

# Impedance of Real and Artificial Ears

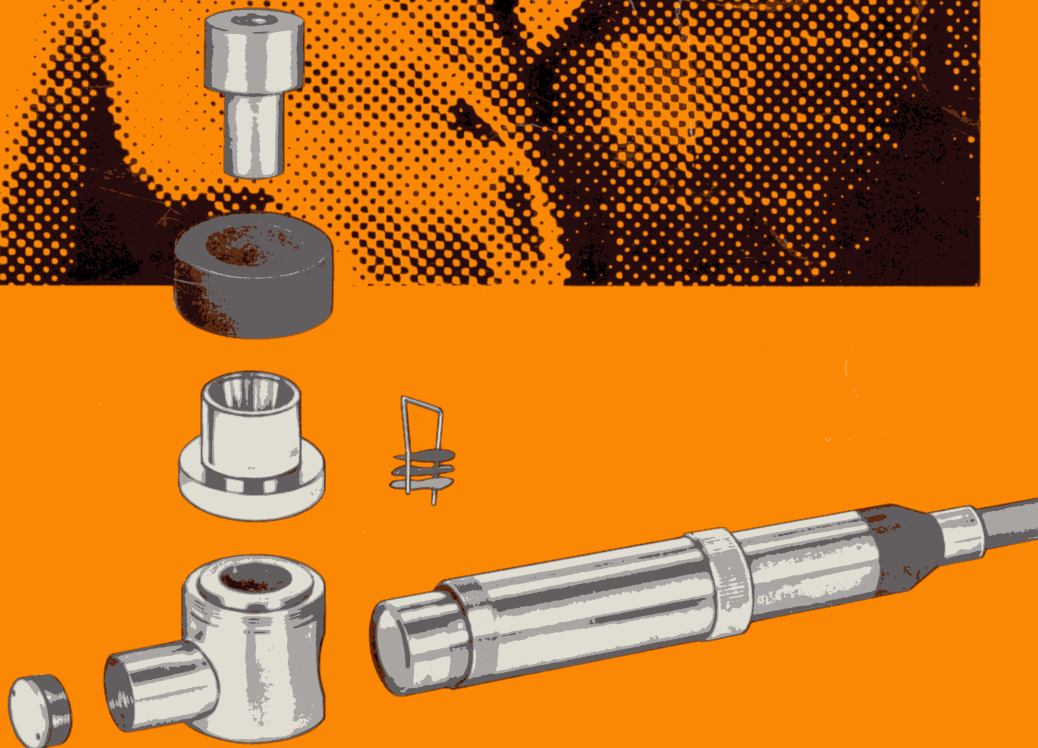

# Impedance of Real and Artificial Ears

<b>PART I: Investigations of a New Insert Earphone Coupler</b> .....	<b>3</b>
(Small Artificial Ear)	
Authors: Per V. Brüel Erling Frederiksen Hilmer Mathiasen Gunnar Rasmussen Erik Sigh	
<b>PART II: Impedance Measurements of Volumes</b> .....	<b>30</b>
Authors: Per V. Brüel Viggo Tarnow	
<b>PART III: Applications of Small Artificial Ears</b> .....	<b>33</b>
Authors: Per V. Brüel Erik Sigh	

# PART I

For helping the hearing aid industry and the users of hearing aids, IEC has described in R 126<sup>1)</sup> — 1961 — an artificial ear called the IEC 2 cm<sup>3</sup> Coupler, which could be used for evaluation of sensitivity and frequency response of hearing aid earphones. A sketch of the coupler is shown in Fig.1, top left.

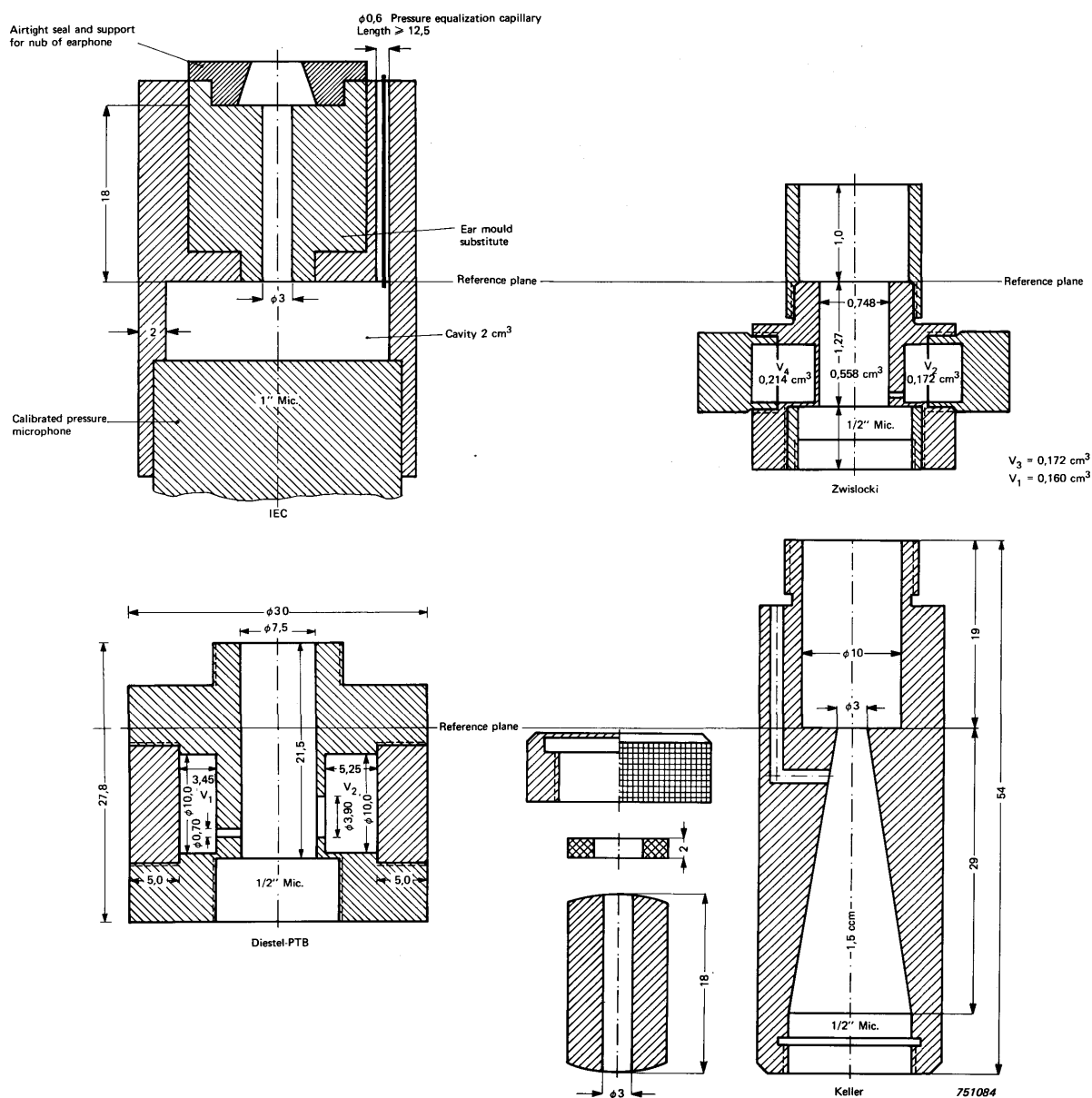

Fig.1. Cross-section and dimensions of the IEC 2 cm<sup>3</sup> coupler, the Zwislocki, Diestel-P.T.B. and the Keller coupler

The coupler consists of a 2 cm<sup>3</sup> volume which should simulate the volume between the tip of the ear mould and the eardrum, including the elasticity of the eardrum and the inner part of the ear canal.

An 18 mm long and 3 mm diameter cylindrical cavity leads from the earphone under test to the volume. This cavity simulates the tubular portion of an average ear mould.

The whole ear device was suggested already in 1949 and described in an ASA standard Z.24.9. The coupler in the present configuration is therefore rather old, and it is now known that both the impedance and the frequency response differ considerably from those of the human ear.

Many investigators have looked into the problem of making a new coupler, for example, Zwislocki<sup>2)</sup>, Diestel<sup>3)</sup> and Keller<sup>4)</sup> together with others have come up with suggestions for revised versions of couplers for insert earphones shown in Fig.1. These attempts will only be briefly touched upon here.

## Requirements

By coupler is normally understood a device which connects the earphone under test to a microphone in such a way that the working load on the earphone is the same as if the earphone was used on a real ear. Furthermore the coupler should be made in such a way that the signal picked up by the microphone as function of frequency is the same as the sound pressure in the ear canal at the eardrum.

If these two requirements can be fulfilled accurately, then the device may be called an artificial ear, completely in analogy with the terms used in the IEC R 318<sup>5)</sup> which describes an artificial ear intended for calibration of supra-aural earphones.

The most important factor for an artificial ear is that it should simulate the impedance of the human ear correctly, since the working load under which the earphone transmits the signal into the ear is completely dependent on the input impedance, especially if the output impedance of the earphone itself is high.

It is also desirable to measure the frequency response of the insert earphones under test when they are mounted on the coupler. It is believed that the right place for the microphone position is a point in the coupler where the sound pressure is simulated as closely as possible to that at the human eardrum.

A third requirement for the insert earphone coupler is that it should be possible objectively to test noise protection ear plugs in the artificial ear. If that could be done, the present cumbersome test of ear plugs could be avoided where the usual test procedure partly involves subjective investigations that are extremely slow, tiresome and inaccurate.

If these three conditions are to be fulfilled: impedance, frequency response and possibility of testing ear plugs, it can be seen that the artificial ear should be built very closely in form and dimensions to the real ear, so that the same internal resonances will apply in both cases. Also the first part of the ear canal should have the same physical dimensions as the real ear for mounting the different ear plugs used for noise protection and the ear inserts used for connecting an earphone through a tube to the ear.

It is required that the artificial ear should be made of hard materials, for which reason some of the dimensions of the artificial ear need to be different from the average dimensions of the real ear. As flesh is rather soft and has a compliance which cannot be duplicated mechanically, some of the dimensions have to be slightly larger in the artificial ear. However, if the dimensions which are responsible for the internal resonance system may be maintained, then the other dimensions can be changed slightly without problems except for the highest frequencies where transverse resonances could be expected.

Concerning the microphone, it is believed that it should simulate the eardrum as far as possible both in size and position. It would have been desirable if the microphone could also simulate the impedance of the eardrum, but as the first resonance in the middle ear is approx. 1300 Hz, it is not possible to make a sensible microphone which can simulate the impedance, however, by placing a resonator close to the microphone it is possible to simulate the impedance very accurately.

To obtain the right sound pressure as a function of frequency, both the size and the position of the microphone are important. There is a practical possibility of choosing either a 1/4" microphone with an active diaphragm of approx. 3,5 mm or a 1/2" microphone with an active diaphragm of approx. 7 mm.

The 1/4" microphone is too small and has less area than the eardrum, while the 1/2" microphone is slightly too big. On the other hand the diaphragm of the 1/2" microphone does not move at the edges, it is completely rigid, whereas the eardrum moves somewhat at the edges giving the human eardrum a larger effective area. Taking this into account, it seems that the 1/2" microphone comes very close to the ideal microphone which could be used in the artificial ear.

As regards the position of the microphone, it would again be most convenient to simulate the human ear as closely as possible by placing the microphone in the artificial ear close to its natural place and having the same angle of incidence to the cylindrical cavity as the one found in human ear canals.

However, a small problem which has to be considered, is that when an insert earphone is mounted in the human ear, the air in the ear will have a temperature of approx. 35°C and a correspondingly higher sound velocity, whereas in the artificial ear used in the laboratory the air would have a room temperature of approx. 21°C and a correspondingly lower sound velocity. This affects the resonance frequencies. The problem can be solved either by heating the artificial ear to approx. 35°C when in use, or by making all the dimensions in the artificial ear 2,5% smaller than the dimensions that are calculated from the measurements of the real ear.

## Impedance

The impedance of a closed volume, a tube or a membrane, is normally defined as the ratio between the effective sound pressure  $p$  and the volume velocity written as:

$$Z = \frac{P}{\Delta V \omega} \quad \text{with dimensions} \quad \left( \frac{M}{TL^4} \right)$$

where the volume velocity is the volume displacement  $\Delta V$  times angular frequency.

The impedance of a closed volume for low frequencies can be expressed as follows:

$$Z = \frac{1,4 \times P_0}{V j \omega} \quad \left( \frac{M}{TL^4} \right)$$

where  $P_0$  is the static pressure.

As can be seen, the impedance is inversely proportional to the frequency.

Since this constant change with frequency makes the use of the impedance somewhat unpractical for our work, the concept of the equivalent volume will be used whereby the multiplication with frequency can be omitted. In other words, we compare the impedance with the impedance of an equivalent volume which gives the same value. (See Part II.)

Since a large volume has a low impedance and a small volume a high impedance, the use of equivalent volumes gives inverse values, but the advantage is that one gets a physical impression directly related to the values obtained. Therefore, in all our measurements here, the impedance will be expressed in equivalent volumes. For low frequencies, where there is no internal resonance, the equivalent volume expressed will be the same as the physical coupler volume.

In impedance measurements there is normally a phase difference between the sound pressure and the volume velocity; this phase shift will be disregarded here as it has no practical importance. What is interesting is the sound pressure as function of frequency, and this is only dependent on the numerical value of the impedance and can therefore just as well be expressed in equivalent volumes measured in  $\text{cm}^3$ . (See later under Complex Impedance.)

## Reference Plane

In Fig.2 is shown a sketch of the ear canal with the eardrum and some average dimensions. It is necessary to define a position from where the impedance (or the equivalent volume) should be measured. Many investigators have tried to measure the impedance of the eardrum itself, i.e. they have tried to find the volume velocity of the disc (A) to the sound pressure just in front of the eardrum. To do this directly is a hopeless task, since one can never isolate the eardrum from the rest of the canal, and therefore this is only indirectly possible.

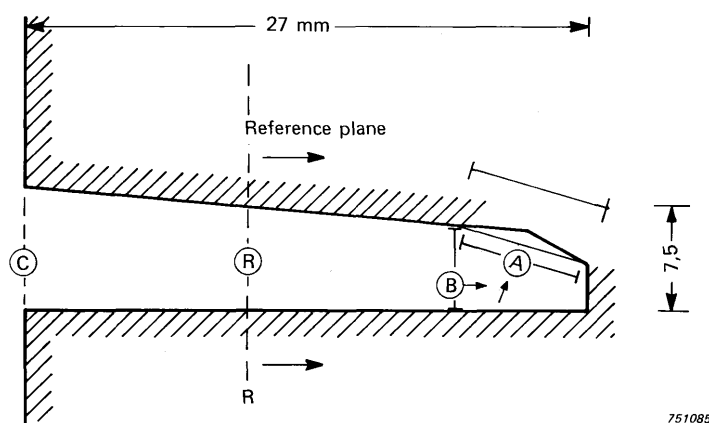

Fig.2. Definition of reference plane for the impedance in the ear canal

The impedance could also be defined at the plane (B) which includes the impedance of the eardrum plus the air volume behind the plane (B) plus the compliance of the flesh in the inner part of the ear canal. Also here it is rather difficult to perform direct measurements, as the inner part of the ear canal is extremely sensitive, and it is difficult to place an airtight seal here.



One could easily measure the impedance at the plane (C) at the entrance of the ear canal, but on the other hand this place is of very little practical significance, since one would never place an earphone here in the human ear. The most logical place to define the impedance plane is in the middle of the ear canal just where the ear moulds normally end. It is here possible to measure the impedance of the ear, because it is easy to seal that part of the ear sufficiently, and consequently direct measurements are theoretically possible. It is also a very practical place to define the impedance, as it is the logical place to insert both ear plugs for noise protection and ear inserts coupled to earphones by a tube, and then again it is the place where the ear moulds end. We shall refer to this place as the reference plane.

Consequently we will construct the artificial ear with an impedance defined at this reference plane to be the same as the impedance measured in human ears at the same plane. The physical dimensions of the outer part of the ear canal should then correspond to those of the human ear.

## **Importance of the Impedance Simulation**

We have to distinguish between two types of earphones, the low-impedance and the high-impedance type. The High-impedance type is the usual electromechanical type, the electrostatic type. Such earphones are characterized by a high resonance frequency and the fact that the membrane deflects a certain amplitude for a certain voltage or current applied to the earphone, almost independent of the impedance into which the earphone is working.

On the contrary, the low-impedance type, like the dynamic type often used in audiometry, is characterized by a low resonance frequency and a flexible membrane which will deflect to a very large amplitude, if necessary, for a certain current applied. In other words, the membrane will deflect until the force from the air pressure balances the force produced by the coil.

If such a low-impedance earphone is used on a coupler or artificial ear, it will produce a sound pressure in this coupler independent of the actual coupler volume or its impedance. In other words, the low-impedance earphones are not critical for the coupler to which they are applied, whereas the high-impedance earphones, which produce a constant volume displacement for a certain input voltage, will produce a sound pressure in the coupler directly proportional to the input impedance of the coupler.

Since the earphones of most hearing aids are of the high-impedance type, it can be seen that the insert earphone coupler must simulate impedance wise the human ear very accurately whereby the input impedance is the most important feature of an artificial ear. If different couplers were to be compared, it should always be done with a high-impedance source and not with a low-impedance earphone as often seen in literature, because the low-impedance source does not reveal any differences in the couplers.

Due to the fact that we normally do not know the impedance of the earphone as a function of frequency, it is not possible to make any correction for a wrong impedance of the artificial ear. A correction can be made for the frequency response and also for the sensitivity, if the response curve of the artificial ear is not correct. This is why the correct impedance of the artificial ear is extremely important.

## Method of Measurements

Most authors measuring the impedance of the inner part of the ear including the eardrum have used some kind of impedance bridges or in a few cases probe microphones<sup>6)</sup>.

When using an impedance bridge, one always needs to include extra volumes for which it is necessary to correct, and when measuring high impedance or small volumes, these corrections are considerable in relation to the volumes under test, which leads to a high degree of inaccuracy and especially limits the frequency range where these measurements can be made.

Probe microphones are also very difficult to use in connection with small volumes, as the effective volume of the probe tubes is considerable compared to the volumes under test. What is worse is that the effective volumes of the probe tubes vary significantly with frequency.

Already in 1961<sup>7)</sup> in connection with the work on artificial ears for audiometric earphones, a technique was used in which a condenser microphone produced a known volume displacement which was independent of the impedance into which the transmitter worked, since the transmitter had an extremely high internal impedance. The sound pressure produced in the volume was directly related to the impedance of the equivalent volume or the volume of the artificial ear.

This technique worked well for the bigger artificial ear under construction at that time, and the work was later used by IEC for standardizing an artificial ear for supra-aural earphones<sup>5)</sup>. It would have been very convenient if the same technique could have been used for constructing a small artificial ear, but as there was only room for placing two 1/8" microphones at the reference plane in the ear canal, it was unsuitable since the sensitivity of the 1/8" microphones for both transmitter and receiver was not high enough.

However, with the present day techniques with amplifiers with lower noise levels, selective amplifiers with narrow bands which can track very accurately the signal of the transmitter, it has been possible to make the measurements. The measurement set-up is shown in Fig.3.

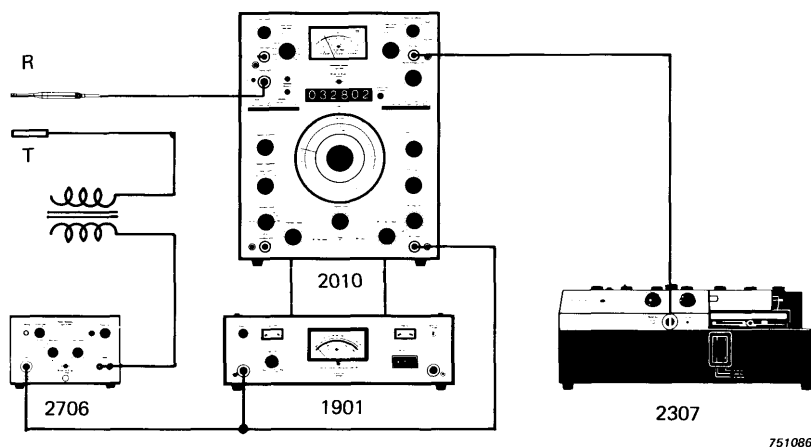
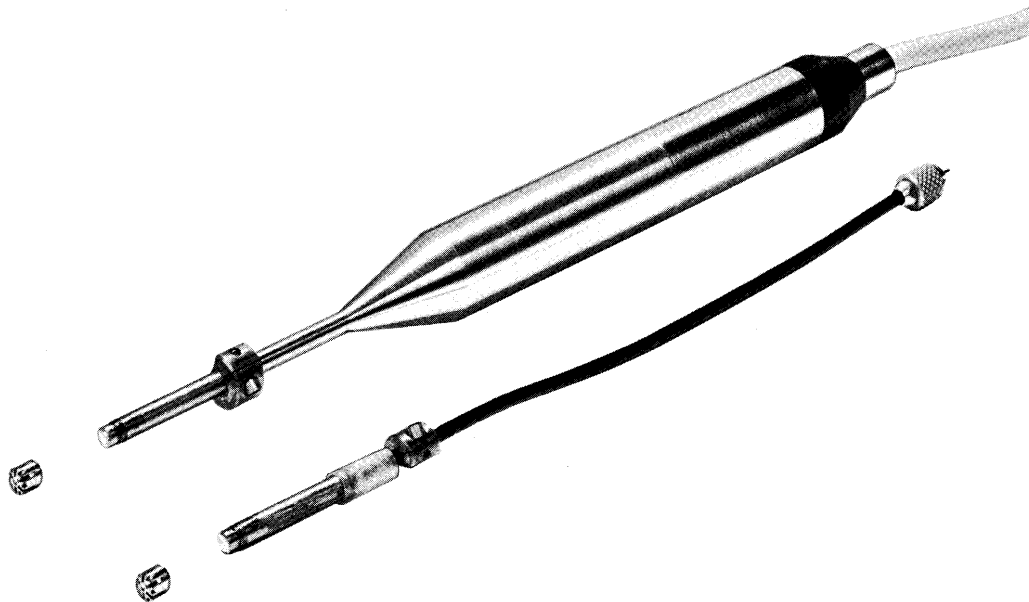
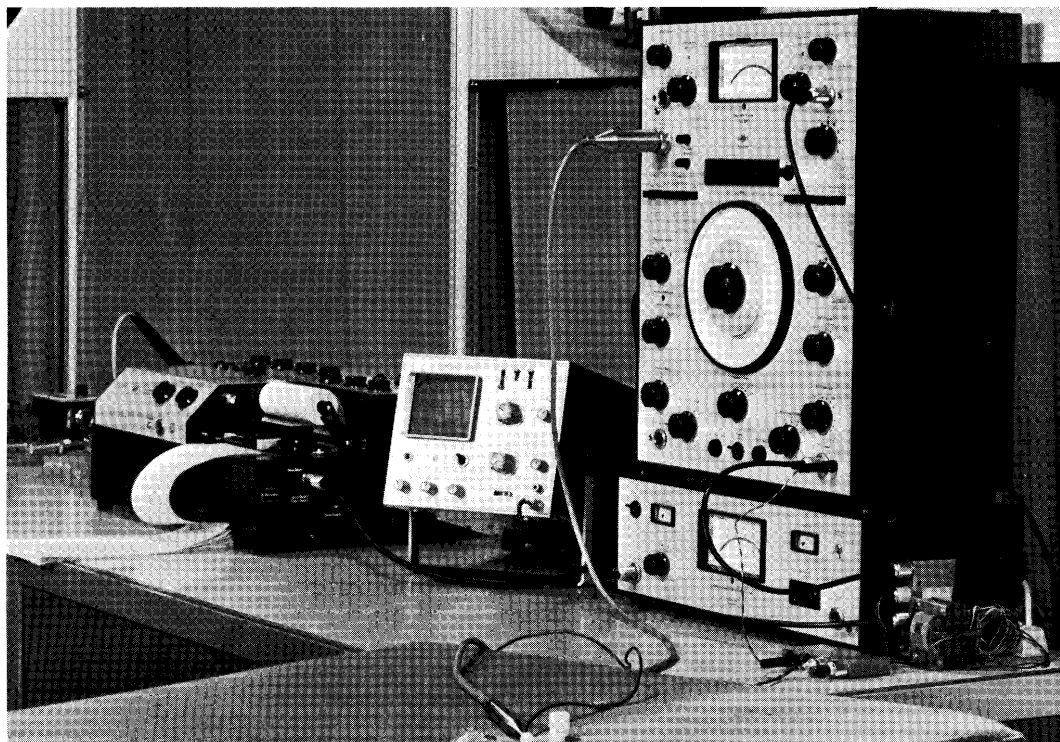

Fig.3. Set-up for direct measurement of acoustical impedance (equivalent volume) at different places in the ear canal





*Fig.4. Receiver microphone with a specially low-stressed diaphragm and a low-noise preamplifier together with the transmitter microphone (a standard 1/8" Condenser Microphone Type 4138). The protecting grids are not used during measurements. The variable stops are used to position the microphones exactly in the reference plane*



*Fig.5. Recorder 2307, Oscillator-Analyzer 2010, Tracking Frequency Multiplier 1901, Power Amplifier 2706, transformer, preamplifier and microphones used for direct impedance measurements. Close to the microphones also the 0,5 and 1 cm<sup>3</sup> calibrating volumes*

To the transmitter microphone a clean AC voltage with peak values of approx. 260 V is applied. This will produce a sound signal in the ear canal with double frequencies but by using the Multiplier Type 1901, the Analyzer Type 2010 can track the double frequencies and reject all unnecessary noise.

If a polarization voltage on the transmitter was used, it could transmit the sound signal with the same frequency as that supplied from the oscillator, but since the receiving microphone placed very close to the transmitter microphone should detect signals in the order of  $2 \mu\text{V}$ , one has a voltage ratio between transmitter and receiver of approx.  $100 \times 10^6$  which makes the electrical screening rather critical. However, by avoiding the polarization voltage and using the frequency doubling in the transmitter, these screening problems are diminished considerably. Fig.4 shows the transmitter and receiver microphones and Fig.5 the electronic instruments.

An advantage of this whole measurement set-up is that it is extremely easy to calibrate. The transmitter and receiver microphone are placed in a known volume and the sound pressure as function of frequency is recorded and the system is calibrated without adjusting any knobs or making any calculations or assumptions. Three calibrating volumes are used: 0,5, 1 and 2  $\text{cm}^3$ .

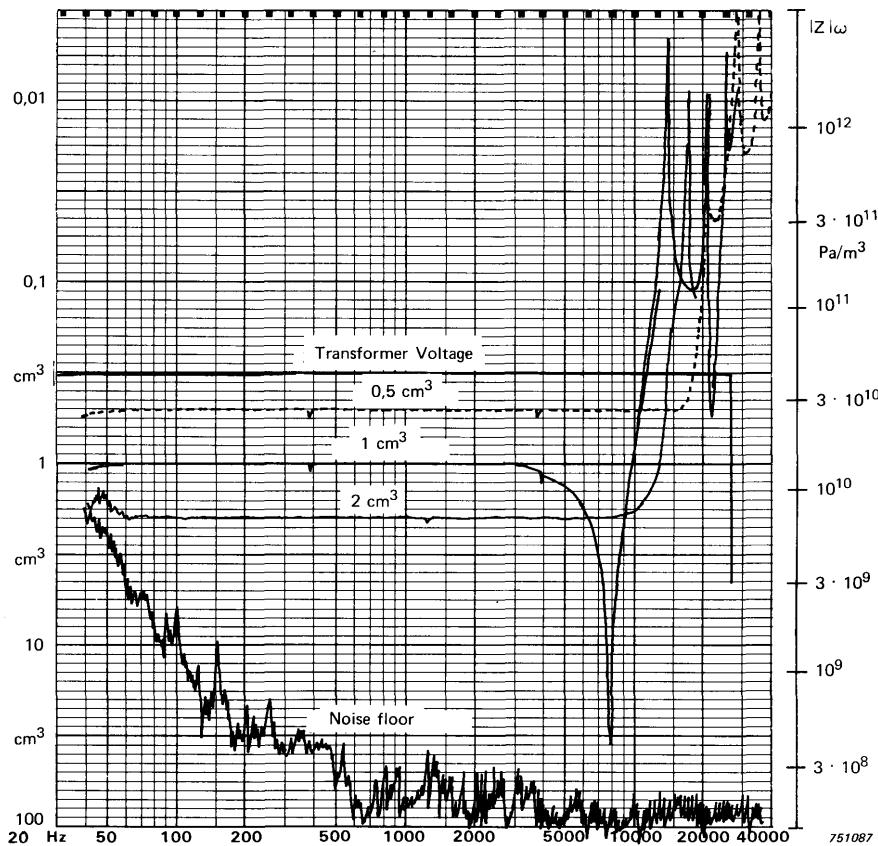
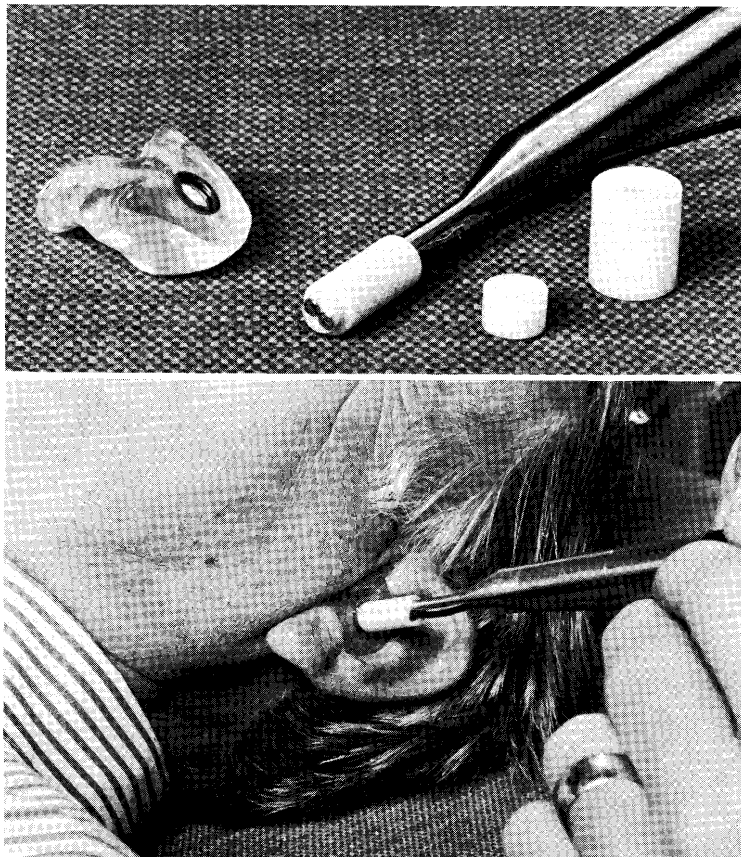

Fig.6. Recording of transmitter voltage, adjusted against 0,5, 1 and 2  $\text{cm}^3$  reference volumes and finally recording of the noise floor (receiver microphone in human ear)

Fig.6 shows recordings of some calibration volumes of 0,5, 1 and 2 cm<sup>3</sup> together with a recording of the noise floor. The noise floor is recorded on a human being including the sound from flowing blood and the inevitable movements of the person under test. It can be seen that all the reference volumes have completely flat spectra of sound pressure up to the point where one begins to have internal resonances in the coupler. Also the spacing between the volumes is correctly expressed in dB. A doubling of the volume corresponds to a 6 dB decrease in the pressure.

## Measurements through Ear Moulds

Theoretically it should be possible to measure the impedance of the inner part of the ear through ear moulds by connecting the two microphones (similar to an earphone) through the locking ring in the ear moulds. This has been tried, and in Fig.7 is shown a photo of a measurement arrangement through ear moulds on a real ear. The ear moulds have to be greased a little to prevent too large a leakage, on the other hand, a leakage is necessary because one cannot tolerate any static pressure on the microphones.



*Fig.7. The two 3 mm microphones placed in a holder formed as the hub of a hearing aid earphone for measuring the impedance presented to the earphone together with two reference volumes. Below: impedance measurements on an ear mould placed in human ear*

Fig.7 shows the two microphones placed at the entrance of an ear mould of an insert earphone. In this way it is possible to measure the impedance directly in an ear mould, since the microphones lock into the ear moulds in the same way as the hub of the earphone. In the picture is also shown a 1 cm<sup>3</sup> volume and a 0,5 cm<sup>3</sup> volume which can be locked onto the two microphones for calibration.

In Fig.8 the results from four different ears are recorded. It can be seen that the variation in impedance is enormous and practically the whole impedance is determined by the ear moulds themselves, since the resonances and antiresonances all correspond to

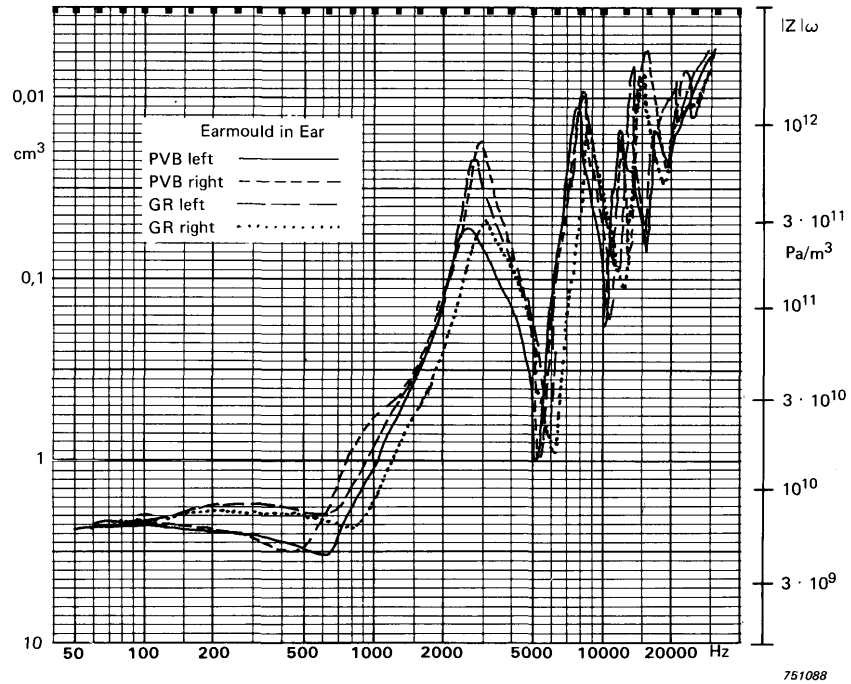

Fig.8. Measurement of impedance of 4 different human ears fitted with ear moulds

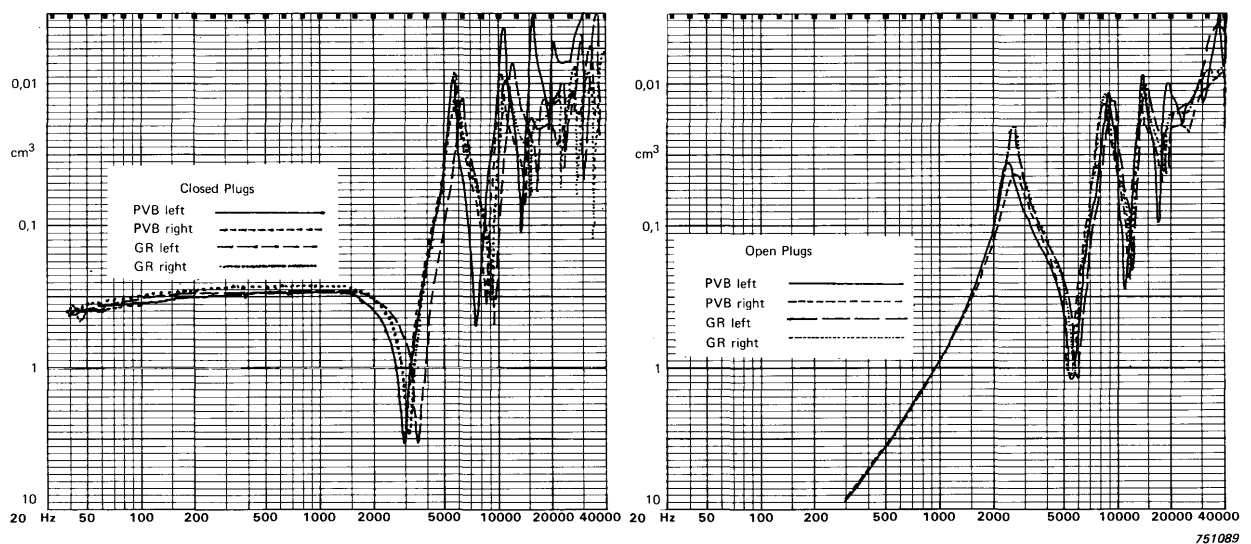

Fig.9. Impedance (equivalent volume) of the canals in the ear moulds. Left: closed plugs. Right: open plugs

the length of the canal in the ear moulds. The influence of the impedance of the inner part of the ear is therefore very small, and it is difficult to try to measure the impedance through the narrow canal in an ear mould.

It is the same problems which arise when using an impedance bridge, where also the main impedance is in the connecting tubes. To get an impression of the impedance of the ear moulds the curves shown in Fig.9 are measured for both closed and open plugs, however, no attempt will be made to use the information to calculate the impedance of the ear canal.

## Measurements at the Reference Plane

It is much better to measure the impedance directly at the tip of the ear mould, where we have defined the reference plane. Four different ear moulds were made up, and two tubes in each were inserted for guiding the microphones, Fig.10. Special stops on both the receiver and transmitter microphones ensured that the diaphragms of the microphones were situated exactly at the reference plane. (See Fig.7.)

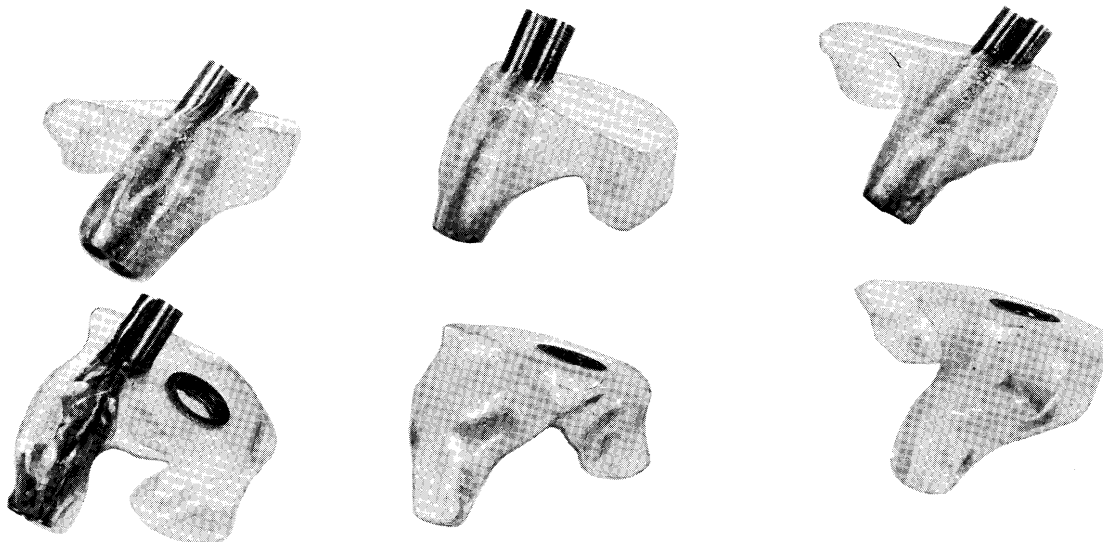

*Fig.10. Ear moulds with inserted guiding tubes for the two microphones and two other ear moulds used for measurements through ear mould canals*

The four ears chosen, belonging to two different persons, were just as normal as possible. The ear canal of one of the persons under test is slightly larger than normal, whereas the size of the ear canal of the other person is a bit below normal. Also the length of the ear canals differ slightly, but is very close to the average figure. The two persons have a normal hearing, and there was no sign of pathological changes. Their age is approx. 55 and 60 years.

As shown in Fig.11, the impedance curves expressed in  $\text{cm}^3$  are recorded several times with some time intervals in between each measurement. There is a fairly good agreement between the measurements on each ear. Small changes can be noticed, they can be explained by general inaccuracies in the measurement set-up, mainly due to the sensitive receiver microphones which have membranes with less tension than normal and are slightly sensitive to mechanical stress.

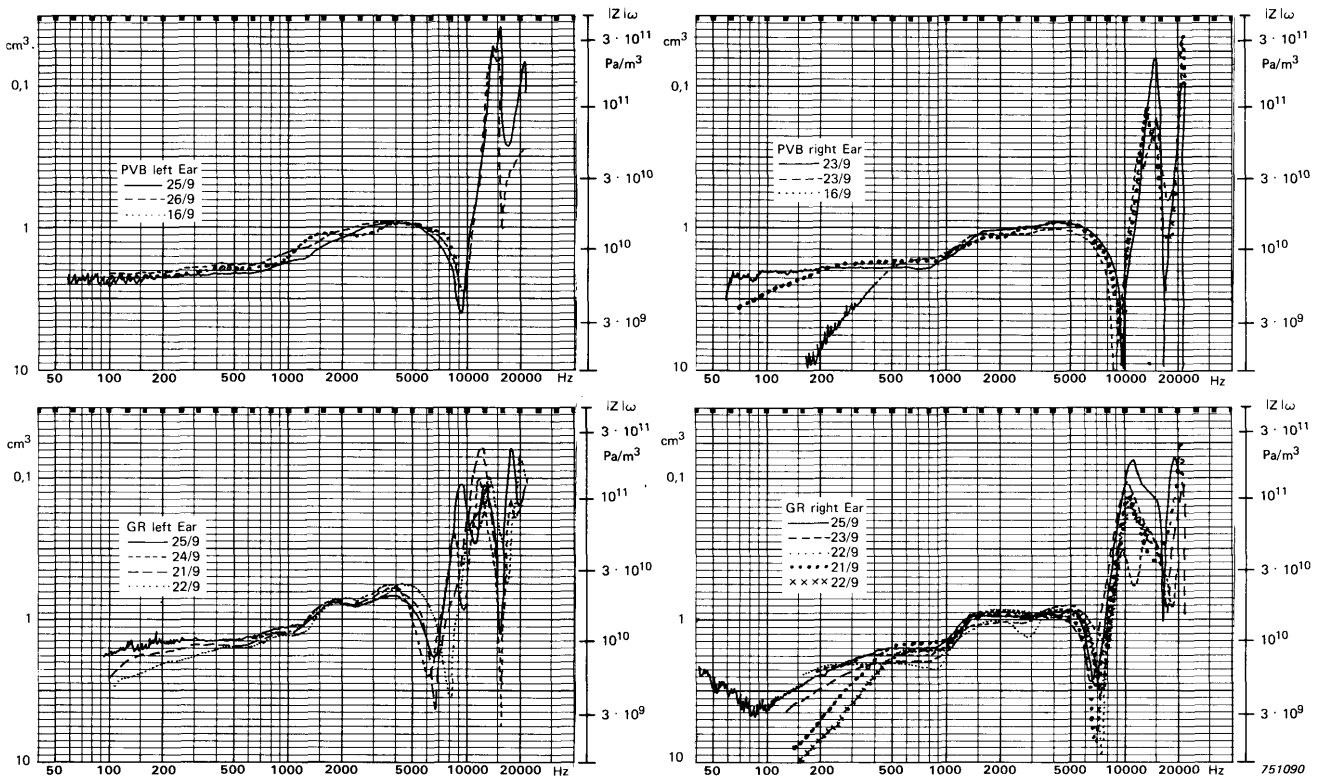

Fig.11. Four different ears measured at reference plane (tip of ear mould). Measurements repeated on different days

Other possibilities for the variations can be that the ear moulds are not placed exactly in the same position each time or not pressed into the ear in the same way everytime. Also the impedance of the ear in fact changes from time to time. However, in general, it can be said that the measurements are very accurate taking into consideration the difficulties involved. The difference from ear to ear is quite significant which, of course, is not surprising.

An average and somewhat stylized curve of all the four ears is shown in Fig.12. It is now possible to explain why the curve has the form we have measured.

First of all, the leakage into the open air is completely dependent on how well the ear moulds are fitted to the ear, and how tight the microphones are sealed in the guiding tubes. If a "well-formed" ear mould is made individually for the person and placed in the ear without grease, it is quite normal that the cut-off frequency due to leakage is approx. 150 to 200 Hz. The relatively flat part of the curve from 300 to 600 Hz represents the volume of the ear canal from the tip of the ear mould. In this volume is also included the low-frequency impedance of the eardrum which in this frequency region below its first resonance frequency is entirely stiffness controlled and will consequently show up in this diagram as a nearly constant volume against frequency. The size of the total volume is approx. 1,7 cm<sup>3</sup> at 500 Hz.

It can be seen that the curve is slightly tilted, giving an apparently larger volume at the very low frequencies. The reason for this is that the compression in the sound waves is no more adiabatic. This is because the sound interacts thermally with the inner surface of the ear canal, which, because of the existence of many small hairs, presents a large surface area. We therefore have to specify the volume for a certain fixed frequency.



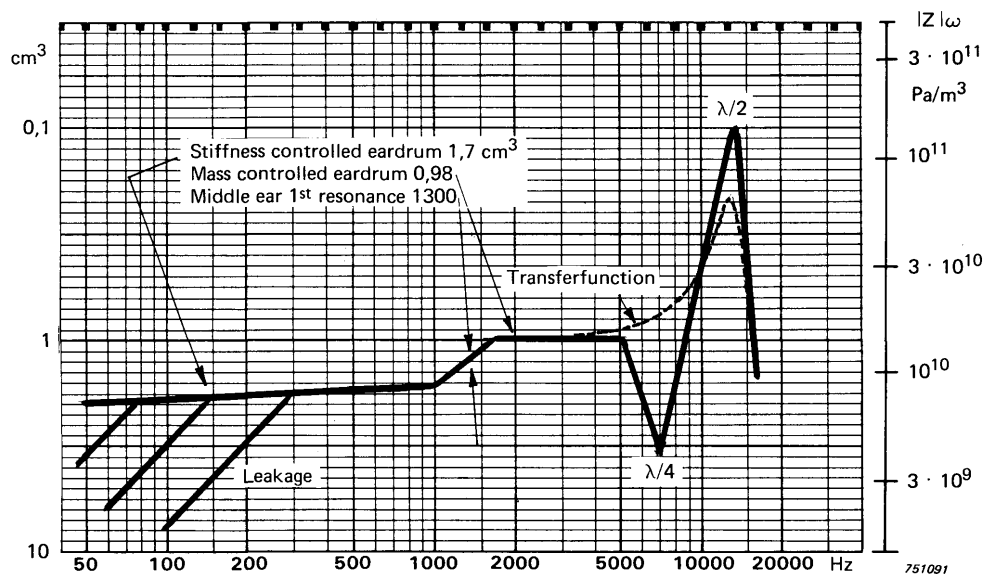

Fig.12. Average curve of the four ears measured in Fig.11 indicating leakage, low-frequency volume, middle ear resonance, high-frequency volume, antiresonance at  $\lambda/4$  and first length resonance at  $\lambda/2$

When the frequency increases, we reach the first resonance of the middle ear through the eardrum where the impedance changes from stiffness controlled to mass controlled during a resonance at approx. 1300 Hz.

The next flat portion of the curve corresponds to the volume in the ear canal from the reference plane, but excluding the impedance of the middle ear, as this is now blocked by the mass of the eardrum.

The first resonance of the middle ear can therefore be determined as the middle point of the steep line between the two flat portions. The slope of this line is an indication of the damping in the middle ear, and one can see that no overswing occurs, thus the damping is rather high, approx.  $Q = 3,5$ .

At approx. 7000 Hz we obtain an antiresonance corresponding to  $\lambda/4$  of a wavelength in the air column in the ear canal from the reference plane to the other end, and at approx. 13 kHz we have the first length resonance in the same air column.

The antiresonance is due to the fact that for a  $1/4$  wavelength of the sound wave the tube has minimum impedance at the microphone end whereas the sound pressure in the other end of the tube is high at the corresponding frequency. See Fig.13.

## Transfer Function

From Fig.13 it can be seen that if the microphone is placed at the other end of the closed volume between the ear mould and the eardrum, then the sound pressure at the eardrum end is different from that at the ear mould end. The difference will only show up for frequencies above 3000 Hz, because it is only the first length resonance which has an influence on the pressure distribution in the volume.

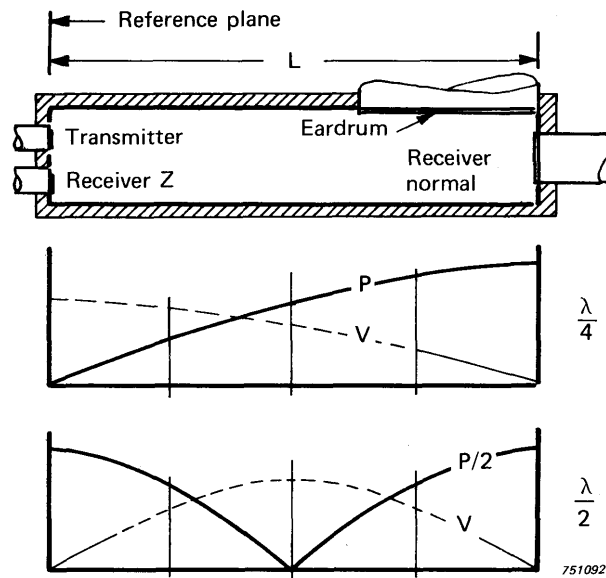

Fig.13. Illustration of antiresonance and first length resonance in a tube driven by a high-impedance transmitter. Note: no pressure drop at the opposite end

Below that, i.e. for frequencies where the volume dimensions are small compared to the wavelength, there is no difference between the impedance curve and the transfer function. We will define the transfer function as the sound pressure measured at the position of the eardrum when a constant volume displacement is generated at the tip of the ear mould. The constant volume displacement can simply be realized by driving a condenser microphone with a high resonance frequency at a constant voltage.

This transfer function can also be compared to the output of an artificial ear when it is loaded with a high-impedance earphone.

	PVB Left	PVB Right	GR Left	GR Right	Unit	Aver- age
Eff. Vol. 500 Hz	1,9	1,8	1,45	1,65	cm <sup>3</sup>	1,7
Eff. Vol. 2000 Hz	1,05	1,05	0,8	1,0	cm <sup>3</sup>	0,98
Middle Ear Resonance	1300	1250	1350	1200	Hz	1300
First Length Resonance	13	14	11	10,2	kHz	13
Effective Length of Air Colum in Volume 1	13	12	15	17	mm	13
Eff. Vol. of Middle Ear Through Eardrum	0,85	0,75	0,65	0,65	cm <sup>3</sup>	0,72

As we shall see later, this transfer function can be used to check an artificial ear instead of using the point impedance measurements, as the transfer function is far easier to record.

From the design goal in Fig.12 it is now possible to construct an instrument which will perform very closely to this curve. In the table are given the main average figures for the four ears plus the average figures forming the design criterion for an artificial ear.

## Complex Impedance versus Impedance Modulus

When the impedance of the ear was earlier described in literature, the impedance was always expressed as a complex value composing a real and an imaginary part of a numerical value (Modulus) with additional information about the phase relationship between pressure and velocity.

In the measurements described here, the phase measurements are omitted. The phase information could also be obtained with addition of a phase meter and an extra recorder (Types 2971 and 2307).

The goal here is to construct an artificial ear loading the earphone in the same way as the human ear, and, naturally, it is very important that not only the numerical impedance is correct but also that the correct phase relationship is obtained.

On the other hand, we here try to make an artificial ear which, in form and dimensions, is very close to the real ear, and where all the basic resonances are the same. Consequently, if the numerical value of the impedance is correct, then the phase relationship is automatically correct, even if it is unknown.

It is impossible to imagine a device of which the numerical value of the impedance is correct as a function of frequency, but which has a wrong phase relationship, therefore phase measurements have not been performed directly in these investigations.

## Measurements on other Artificial Ears

Before trying to develop an artificial ear which fits the impedance curves measured, all the couplers referred to at the beginning — the cross sections of which are sketched in Fig.1 — should be investigated.

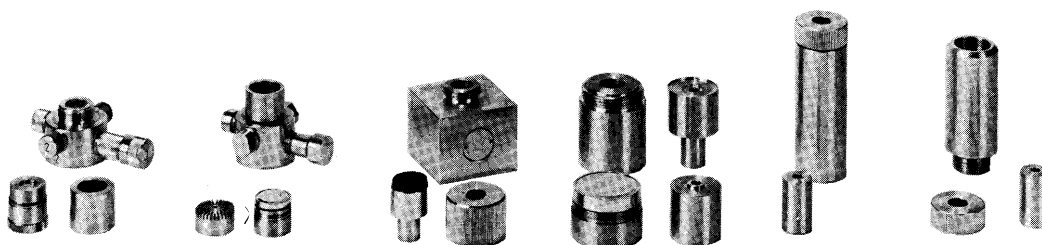

*Fig.14. Photo of the different couplers for which the impedance has been measured at the reference plane. Left: two Zwislocki (B & K and Salomon), Diestel-P.T.B. and IEC 2 cm<sup>3</sup>. Right: two Keller couplers*

The hardware of all ears is shown in Fig.14, and the necessary plugs for connecting the microphones to these ears just at the reference plane are shown in Fig.15 together with the reference volumes used.

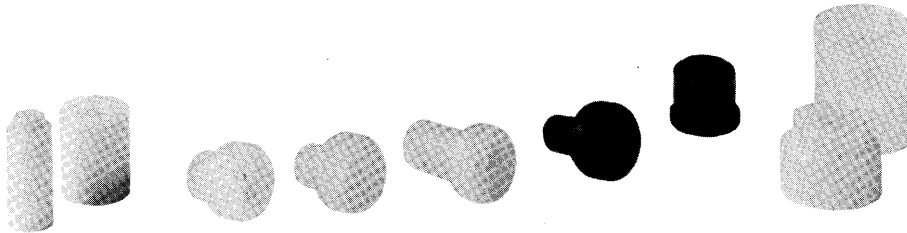

*Fig.15. Connection plugs and reference volumes necessary for testing the couplers shown in Fig.14*

The technique of measurement on the artificial ears is identical to that shown in Fig.3 and used on the human ears. All the artificial ears have been supplied with the prescribed microphones as termination; all of them except the IEC coupler uses 1/2" microphones.

For most of the couplers ear mould simulators also exist, but these have been removed, since the narrow canals will only distort the impedance measurements of the internal ear.

## **Zwislocki**

Five specimens of the Zwislocki ear have been measured, and the results are shown in Fig.16. By comparing the curves, it can be seen that there are rather large differences between the specimens, and none of them really fits the design goal of Fig. 12.

Zwislocki's coupler consists of a centre volume with a 1/2" microphone and four secondary volumes which are coupled to the centre volume through sintered acoustical resistances. These resistances are rather tricky to work with and to install in couplers, and it is assumed that it is those difficulties which have caused the differences measured.

The Zwislocki coupler is also rather complex to make, as it consists of five volumes. Since an artificial ear that fits the curve could be made with only one centre volume and one extra secondary volume, the Zwislocki design seems unnecessarily complicated.

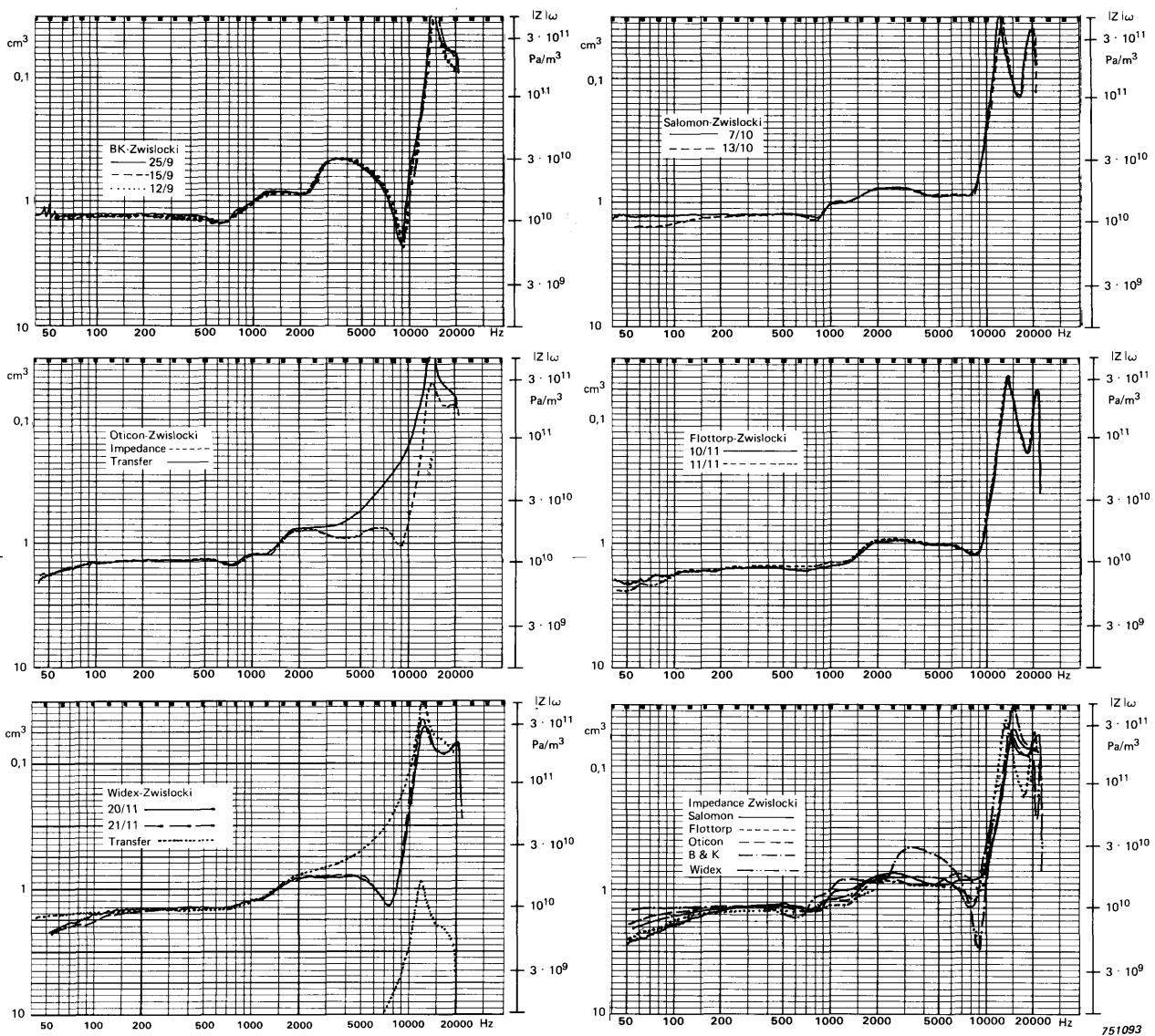

Fig.16. Impedance curves for Zwislocki coupler. Several measurements made at different times. Top left: B & K, right: Salomon. Middle left: Oticon, right: Flottorp. Below left: Widex and right: average of each in one curve

## Diestel, P.T.B.

Prof. Diestel has tried to simplify the Zwislocki coupler by omitting two of the extra volumes and has built the coupler up only with the centre volume and two extra volumes.

The specimens we have tested give the impedance curves shown in Fig.17. By comparing these curves with the design curve in Fig.12, it can be seen that the Diestel coupler fits the goal quite well, even if the lack of damping in the centre volume increases the amplitude at higher frequencies and produces some deviations. At lower frequencies, Diestel's coupler is correct, whereas Zwislocki's seems to be too small. The tested specimen of the Diestel coupler could — with addition of some extra damping for the first length resonance and by changing the eardrum resonance from 1000Hz to 1300Hz — be an ideal artificial ear.

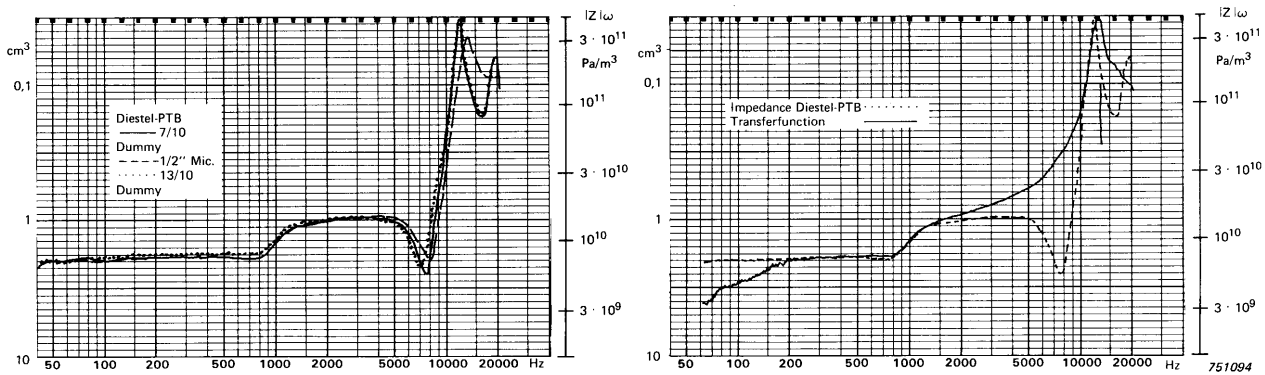

Fig.17. Impedance of Diestel-P.T.B. coupler measured three times with both dummy and real microphones inserted. To the right: the average value (dotted curve) and the transfer function (solid curve)

## IEC 2 cm<sup>3</sup>

The standardized IEC 2 cm<sup>3</sup> coupler which, in reality, consists only of a centre volume connected to a 1" microphone gives an impedance curve (Fig.18) that is flat over a large frequency range and thus does not simulate the impedance change which we have around the first resonance in the middle ear. Even at lower frequencies it is too large and naturally much too large at higher frequencies.

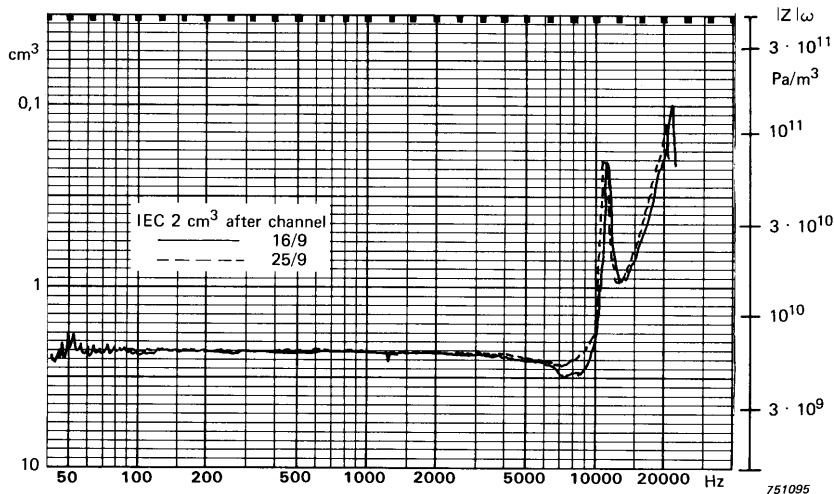

Fig.18. Impedance of the IEC 2 cm<sup>3</sup> at reference plane

Neither the antiresonance nor the resonance at higher frequencies occurs at the right frequencies, so the IEC coupler has a very poor fit to what we would like to have.

## Keller's Conical Coupler

Two specimens of Keller's conical coupler have been measured. They are very much alike, as can be seen from the curve in Fig.19, mainly because it is a very simple conical shape without any coupled volumes to the centre volume. The coupler is quite long and does not simulate the inner part of the ear canal. At lower frequencies, the volume is correct.



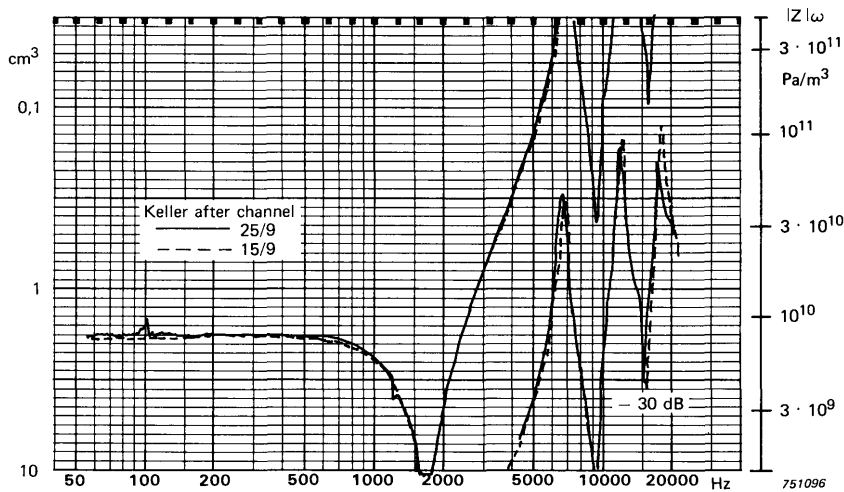

Fig.19. Impedance of the Keller coupler. Two specimens completely alike

As this coupler does not simulate the impedance change of the middle ear and neither the length resonances in the ear canal, Keller's conical coupler, even if it is different from the IEC coupler, is not much better. The advantage of the Keller coupler is its very simple design.

### The Brüel & Kjær Artificial Ear

As already mentioned, it should be a rather straight forward task to construct an artificial ear which fits the design curve of Fig.12. The first attempt, Model I, was constructed according to the drawing made from calculations and shown in Fig.20, left.

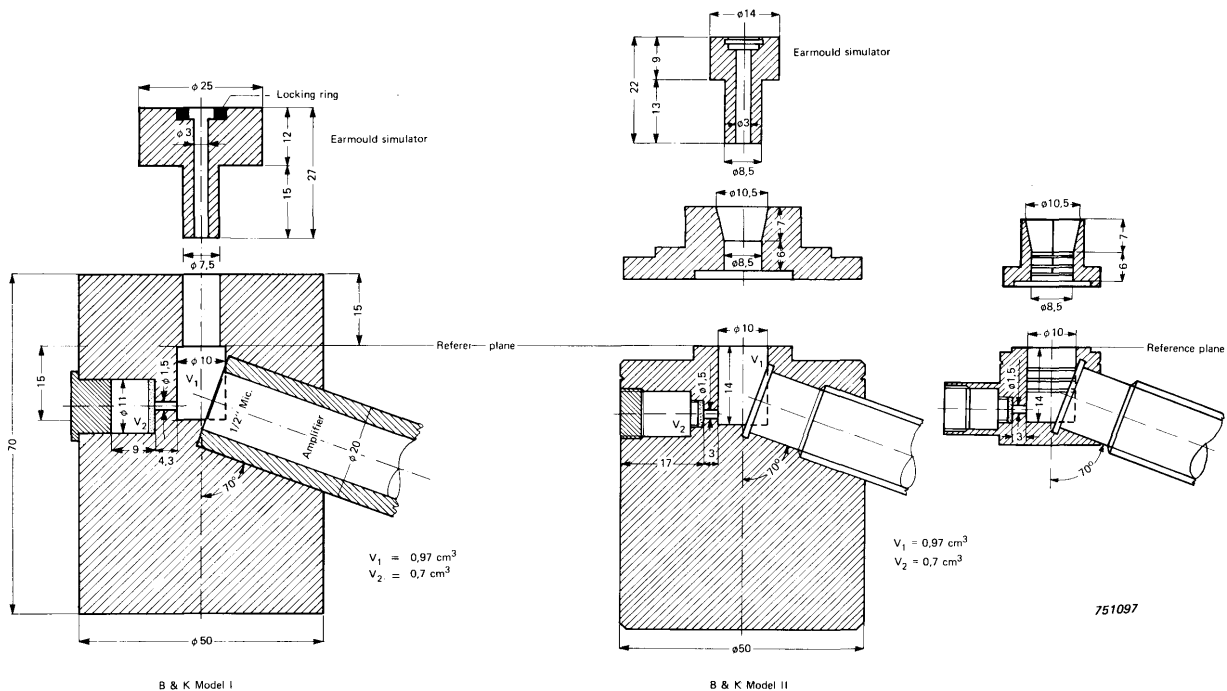

Fig.20. Cross section of the B & K Model I, Model II and Model III Artificial Ears

When Model I was tested, it was found that some modifications were necessary. For example, the outer ear canal should be 8,5 mm in diameter instead of 7,5 mm, the length of the centre volume 14 mm instead of 15 mm and the neck length of the resonator 3 mm instead of 4,3 mm. The impedance curve for Model I is shown in Fig.21.

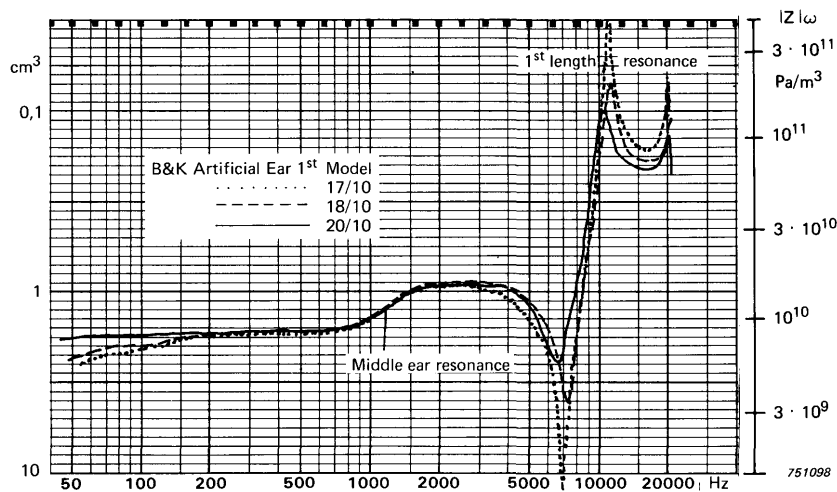

Fig.21. Impedance curve of B & K Model I, where both the middle ear resonance and first length resonance are slightly too low. The three curves have different damping in central volume. Dotted: no damping. Solid: correct damping

The length of the centre volume should fit the first length resonance. It should be at approx. 13 kHz and have a length of approx. 13 mm, but since it is desired to place the microphone at the end of the ear canal with the same angle of incidence with the axis as in the case of the human eardrum, the volume will be slightly tapered at the end, for which reason the length should be increased a little, and finally a length of 14 mm was chosen.

Just opposite the microphone is placed a Helmholtz resonator with a neck, 3 mm long and 1,5 mm in diameter. The volume in the Helmholtz resonator has a numerical value of 0,72 cm<sup>3</sup>, and a sintered filter damps the resonator heavily, so that the Q-value of the resonator is practically the same as the Q-value of the middle ear.

The size of the volume is determined with the assumption of adiabatic compression of the air. Especially when the air has to go through the sintered filter where the surface is very large, the air exchanges heat with the metal in the filter, and consequently the actual volume should be smaller than the one calculated.

The practical or physical volume of the Helmholtz resonator has to be between 0,55 and 0,60 cm<sup>3</sup> for fulfilling the requirement of 0,72 cm<sup>3</sup> when we count on the adiabatic compression.

A small wire mesh is placed into the centre volume to dampen it a little, so that the resonance and antiresonance values approximate the ones found when one measures on real ears.

The outer part of the ear canal, which is 13 mm long, can be removed, so that another ear canal may be installed if the present one is too narrow to fit special ear inserts, etc..

Concerning the diameter of the outer ear, it can be seen from Fig.22 that the diameter should be approx. 7,5 mm for the first 6 mm and have a tapering up to 10,5 mm where the ear canal terminates into free air. However, since flesh is a little compressive, the diameter in the artificial ear has to be slightly larger than the average diameter of the human ear in order to give the same apparent compressibility. A diameter of 8,5 mm is chosen.

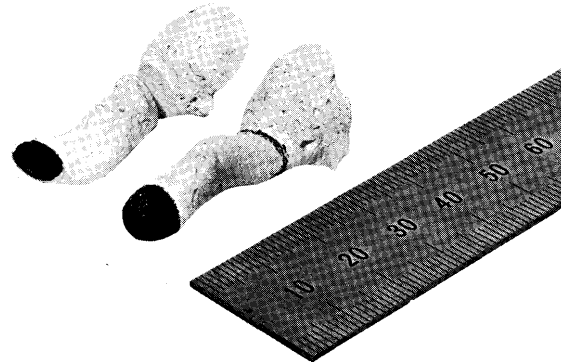
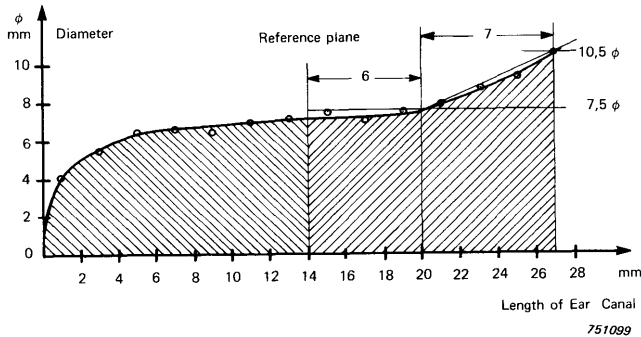

Fig.22. Cross sectional dimensions of the average human ear canal. The curve is based on approx. 100 different ears. To the right: a photo of some moulds used for exact determination of ear canals. The eardrum is black

For measuring on earphones, which are normally used in connection with ear inserts, an ear insert simulator is suggested which is a canal, 22 mm long and 3 mm in diameter. The top end of this simulator has a locking ring of the same type as the one used in ear inserts.

The microphone is a 1/2" microphone which is held rigidly in the artificial ear by means of a special gasket. There is no leakage introduced, since the necessary leakage is performed through the 1/2" microphone.

In Fig.23 is shown a photo of the first Model I made and the final Model II, and Fig.25 shows Model II disassembled into the different parts. The lower part of the artificial ear is one solid block of brass which makes the instrument convenient to use on a laboratory table. However, if the artificial ear is intended to be built into an artificial head or some other place where space is important, the whole artificial ear can be made much smaller, provided that the volumes are machined correctly. See later.

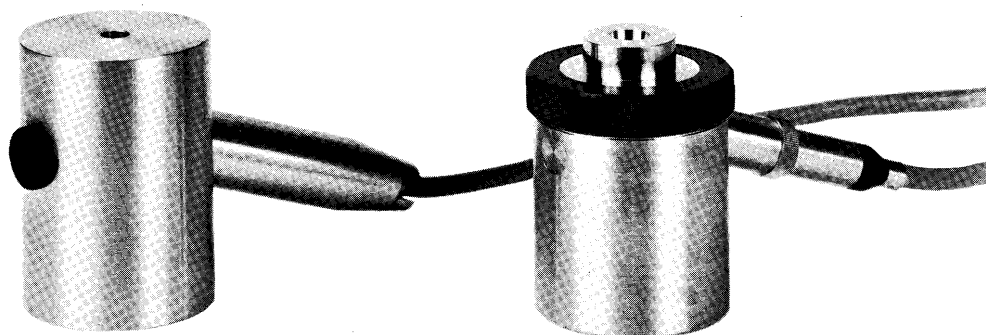
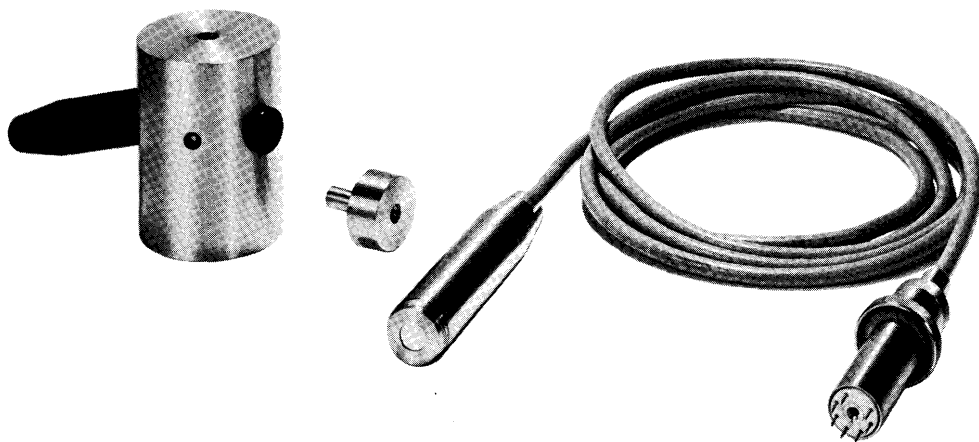
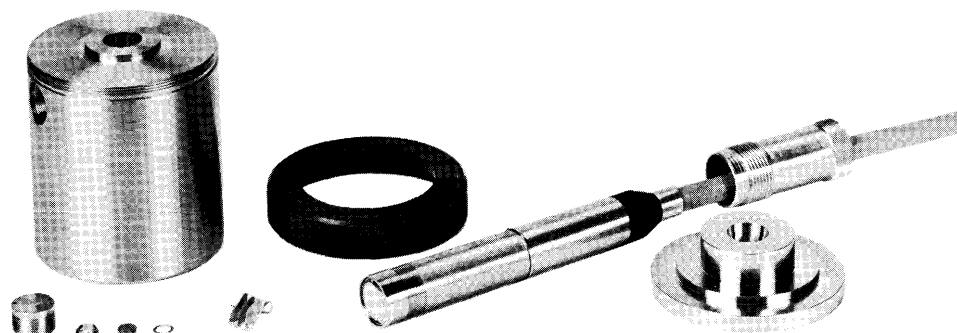

Fig.23. Photo of the B & K Model I and to the right: a photo of the finished instrument Model II



*Fig.24. Photo of Model I with inserted dummy microphone. Ear mould simulator and the microphone assembly*

Besides the precision in machining and the rigid fixing of the microphone, the only critical part is the adjustment of the sintered resistance in the Helmholtz resonator. The right way to adjust this is, of course, to perform an impedance measurement as outlined here. In practice, it can be done simply by using the high-impedance source as transmitter and the built-in 1/2" microphone as receiver and recording the transfer function.



*Fig.25. B & K Model II disassembled in main body, plug for resonator, ring for filter, sintered filter, spacer, central volume damper, 1/2" microphone with holder bushing, outer part of ear canal and holding ring*

This can be done with the measuring equipment shown in Fig.26. The necessary polarization voltage for the transmitter microphone is supplied from either the Heterodyne Analyzer Type 2010 or the Measuring Amplifier Type 2606. By using the 2010, narrow bandwidth reception is possible whereby much noise can be rejected. All measurements are carried out against a reference volume of 1,7 cm<sup>3</sup>. As transmitter a 1/4" microphone is used which, together with the built-in 1/2" receiver microphone, gives sufficient signal to noise ratio. A small holder for the 1/4" transmitter microphone is made, so that it fits both the artificial ear at the reference plane and the reference volume.

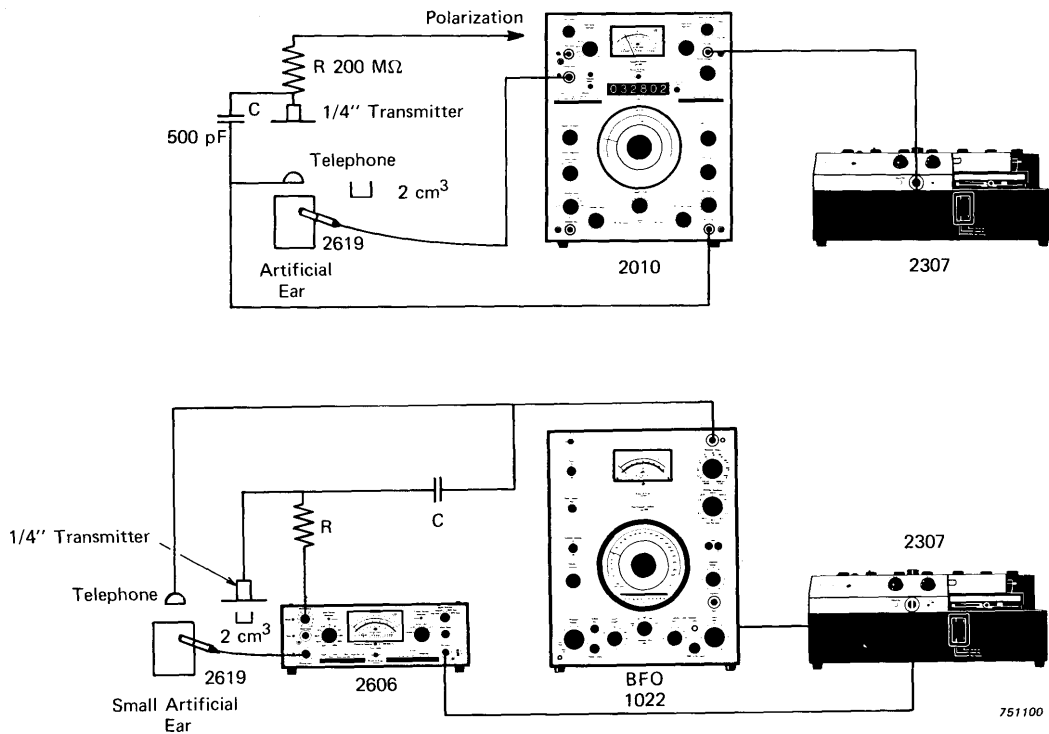

Fig.26. Measurement set-up for control and adjustment of small artificial ears. The same instruments apply in the normal use of the artificial ears. Top: heterodyne analyzer contains both oscillator and selective receiver. Below: Measuring Amplifier Type 2606, Beat Frequency Oscillator Type 1022 to be used for frequency response only

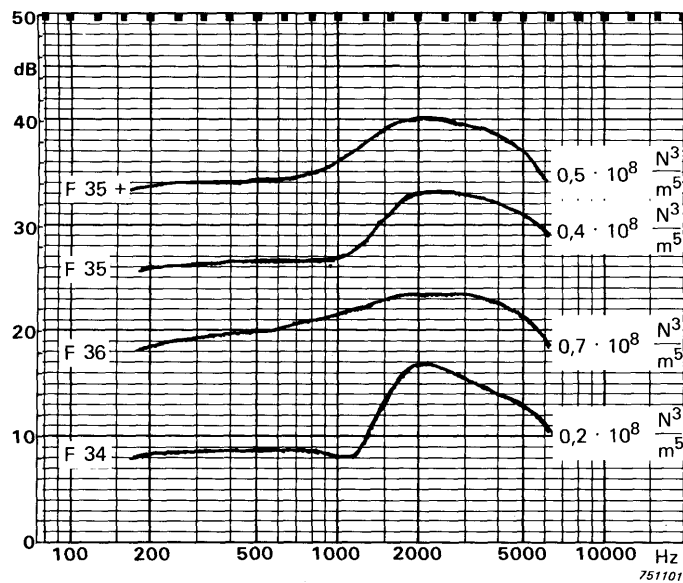

Fig.27. Adjustment of the resistance in the resonator

In this way the following parameters can easily be controlled:

- 1) Volume at 500 Hz
- 2) Resonator resonance frequency (eardrum resonance)
- 3) Damping of resonator (eardrum Q-value)
- 4) Volume at 2000 Hz
- 5) First length resonance
- 6) Damping of length resonance

The damping of the resonator is obtained by a sintered filter which can be available with different acoustical resistances. In practice, the resistance has to be measured in situ, with the filter mounted as the resistance may change when the filter is installed. However, instead of directly measuring the resistance, it is much easier just to look at the transfer function. A tiny amount of nail varnish can be used to adjust the filter resistances, until the transfer function has the right slope at 1300 Hz. Fig.27 shows

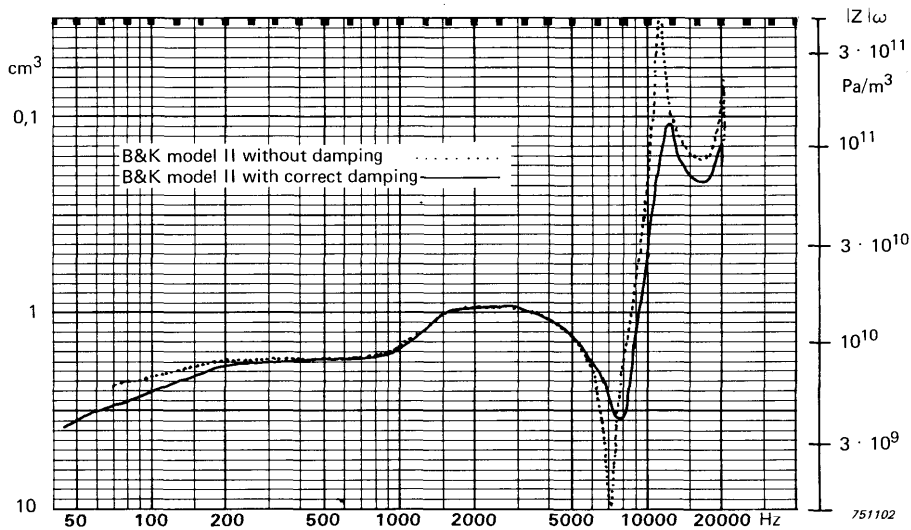

Fig.28. Impedance of B & K Model II with and without the correct damping

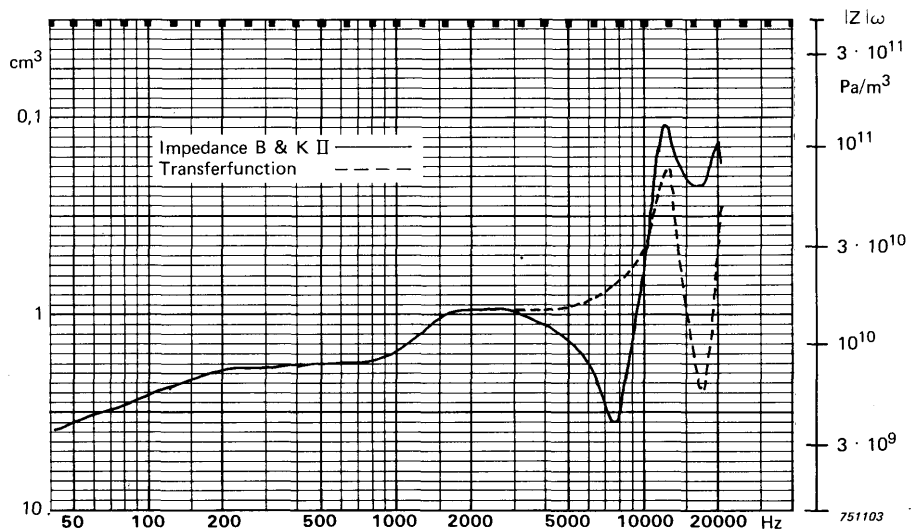

Fig.29. Impedance and transfer function of B & K Model II



some examples where the uppermost curve is correct. No. 2 has a slightly too small resistance, No. 3 a much too high resistance and No. 4 a much too low resistance value.

In Fig.28 is shown a series of impedance curves measured with two 1/8" microphones at the reference plane. It can be seen that the impedance curve is quite close to the design goal. Fig.29 shows both the impedance and the transfer function.

When a hearing aid with a built-in earphone is to be tested either in the free field or in a hearing aid test chamber, it is important that the artificial ear does not disturb by its own size the sound field. For these applications it is important that the artificial ear is as small as possible. A photo of a practical model is shown in Fig.30, and the corresponding drawing is shown in Fig.20, right. Internally, Model III is exactly the same as Model II.

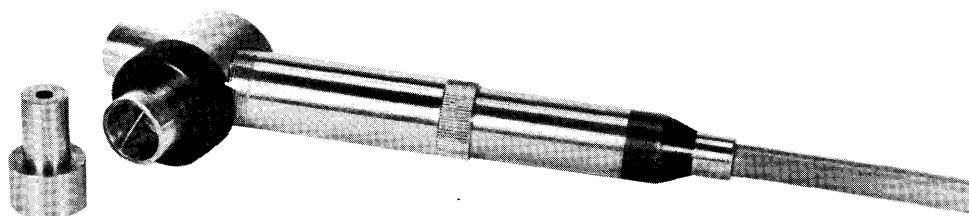

*Fig.30. Photo of B & K Model III for use in free field together with ear mould simulator*

The photo in Fig.31 shows all the parts in Model III plus the 1/4" microphone used as a transmitter, test volume 1,7 cm<sup>3</sup>, the outer ear canal with its separate damping grid and the ear mould simulator. The impedance and the transfer function are shown in Fig.32.

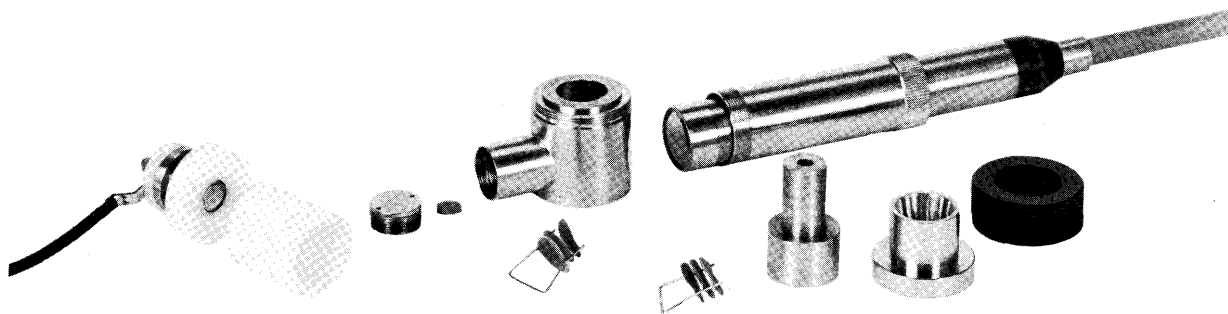

*Fig.31. Photo of B & K Model III disassembled. From left: 1/4" transmitter microphone, 1,7 cm<sup>3</sup> calibration volume, lid for resonator, sintered acoustical resistance for resonator (spacer and holding ring not shown), main body, outer damping, inner damping, 1/2" microphone with tightening ring, amplifier, holding tube, pressing ring and cable, ear mould simulator, outer part of ear canal and assembly nut*

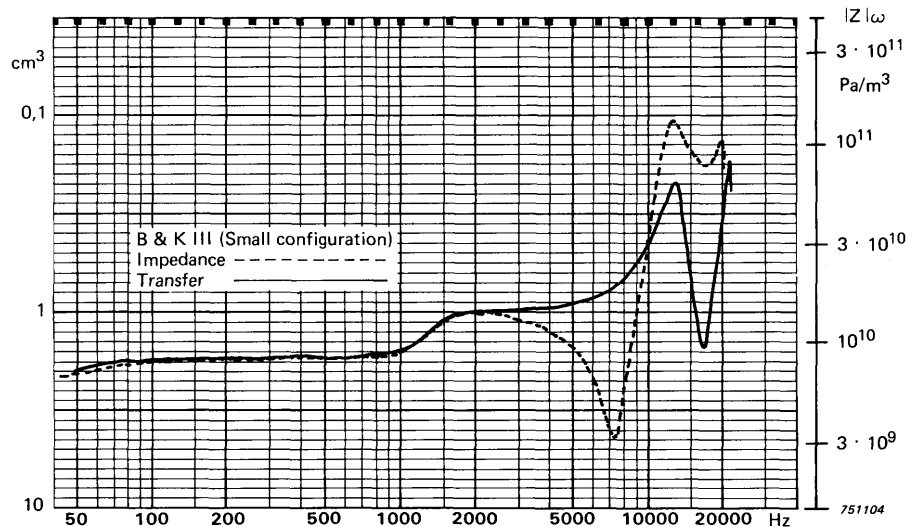

Fig.32. Impedance and transfer function of B & K Model III

Fig.33 shows the transfer function of both Model II and Model III. The two versions of the artificial ear are practically identical. In the figure is also shown the transfer function of the 1,7 cm<sup>3</sup> test volume.

The tops of both Model II and Model III have a diameter which fits the Pistonphone Type 4220, so that a simple sensitivity adjustment can be performed.

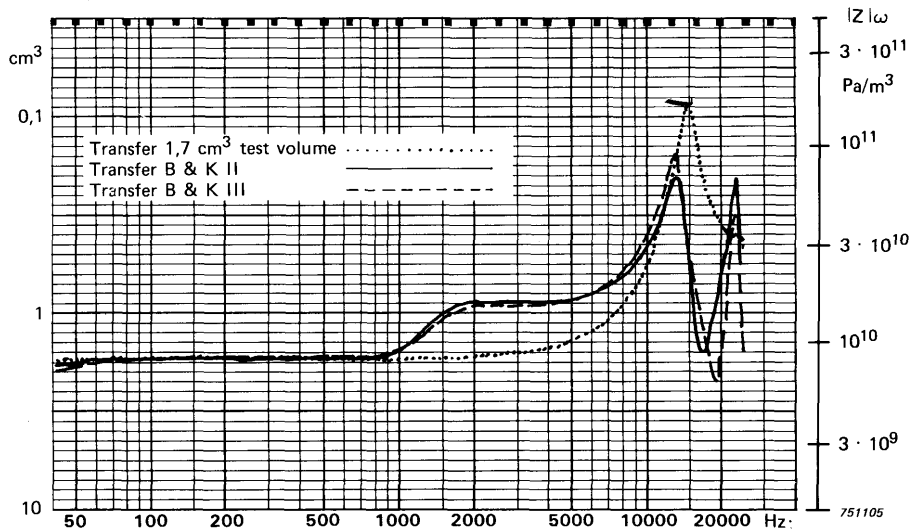
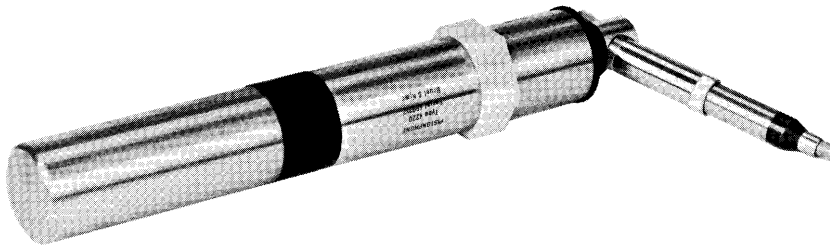
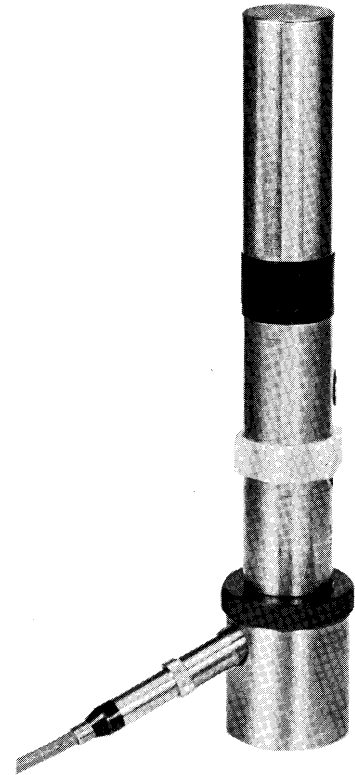

Fig.33. Simplified control of artificial ear by using 1/4" transmitter microphone and measurement set-up shown in Fig.26. Transfer curves of 1,7 cm<sup>3</sup>, control volume and artificial ear Model II and Model III



*Fig.34. Sensitivity adjustment with Pistophone Type 4220 of both Model II and Model III*



## References:

- 1) IEC Standard: "I.E.C. Reference Coupler for the Measurement of Hearing Aids Using Earphones Coupled to the Ear by means of Ear Inserts". Publication 126, Geneve 1961.
- 2) Zwislocki, J. J.: "An Ear-like Coupler for Earphone Calibration". Report LSC-S-9, Lab. of Sensory Communication, Syracuse, New York 1971.
- 3) Diestel & Richter: Progress Report for IEC/SC 29C/WG 6, March 1974. See also: Diestel, H. G.: "Akustischer Kuppler für die Kalibrierung von Einsteckhörern". F.A.S.E. I, Paris 1975.
- 4) Keller & Pedersen: "Ein verbesserter Kuppler für Messungen an Hörgeräten". Z. Instr. 81 (1973) p. 112 — 116.
- 5) IEC: "An I.E.C. Artificial Ear, of the Wide Band Type, for the Calibration of Earphones Used in Audiometry". Publication 318, Geneve 1970.
- 6) Zwislocki, J. J.: "An Acoustic Coupler for Earphone Calibration". Report LSC-S-7, Lab. of Sensory Communication, Syracuse, New York 1970.
- 7) Brüel, Frederiksen & Rasmussen: "Artificial Ears for the Calibration of Earphones of the External Type". Brüel & Kjær Technical Review No. 4/1961 & No. 1/1962.

## PART II

by

*Per V. Brüel and Viggo Tarnow*

### Impedance Measurements of Volumes

In many cases — as described in the previous article — it is a great advantage to describe the hardness or stiffness of a volume not directly by the acoustical impedance but by the impedance of the corresponding volume expressed in  $\text{cm}^3$ .

We shall here see this relation with special reference to the impedance of a long, narrow tube, where the impedance is defined as the ratio between the sound pressure and the volume velocity measured at one end of the tube.

When the wavelength is greater than 2 times the diameter of the tube, the sound pressure may be regarded as constant across the diameter of the tube. In this case the impedance may be defined by the following equation:

$$p = Z\psi$$

where  $p$  is the sound pressure,  $\psi$  is the volume velocity in the cross section of the tube and  $Z$  is the impedance.

In this experiment the volume velocity  $\psi$  is known and the pressure  $p$  is measured, whereby the impedance is determined.

The volume velocity is generated by a microphone used as a transmitter and can be determined using the reciprocity theorem from:

$$\psi = k_e i$$

Here  $k_e$  is the voltage sensitivity of the microphone as a receiver and  $i$  the electric current applied to the microphone. However, when a voltage  $e_e$  is applied to the microphone with capacity  $c_e$  the volume velocity generated is:

$$\psi = k_e j\omega c_e e_e$$

The volume velocity  $\psi$  is therefore proportional to the frequency. If the receiver microphone has a sensitivity  $k_r$  its output voltage will be:

$$e_r = Z k_r k_e j\omega c_e e_e$$

In the experiment the voltage  $e_e$  applied to the transmitter microphone is kept constant and the logarithm of the receiver microphone voltage is recorded, i.e.  $\log|e_r|$ .

At low frequencies the impedance is given by:

$$Z = \frac{\gamma P_0}{j\omega V}$$

where  $V$  is the volume of the tube,  $P_0$  the static pressure and  $\gamma$  the ratio of specific heats, for air  $\gamma = 1,4$ .

The output voltage when  $\omega \rightarrow 0$  is therefore:

$$e_r(0) = \frac{\gamma P_0}{j\omega V} k_r k_e j\omega c_e e_e$$

The following ratio may be found from the level recorder chart:

$$\left| \frac{e_r(\omega)}{e_r(0)} \right| = |Z| \frac{\omega V}{\gamma P_0}$$

Since  $V$  is known  $|Z|$  can therefore be determined.

For the case when the tube is made of stiff walls the impedance is:

$$Z = j \frac{\rho c}{\pi r^2} \cotg(kl)$$

where  $\rho$  is the density of air,  $c$  the velocity of sound,  $r$  the radius of the tube,  $k$  the wave number  $k = \omega / c$ , and  $l$  the length of the tube.

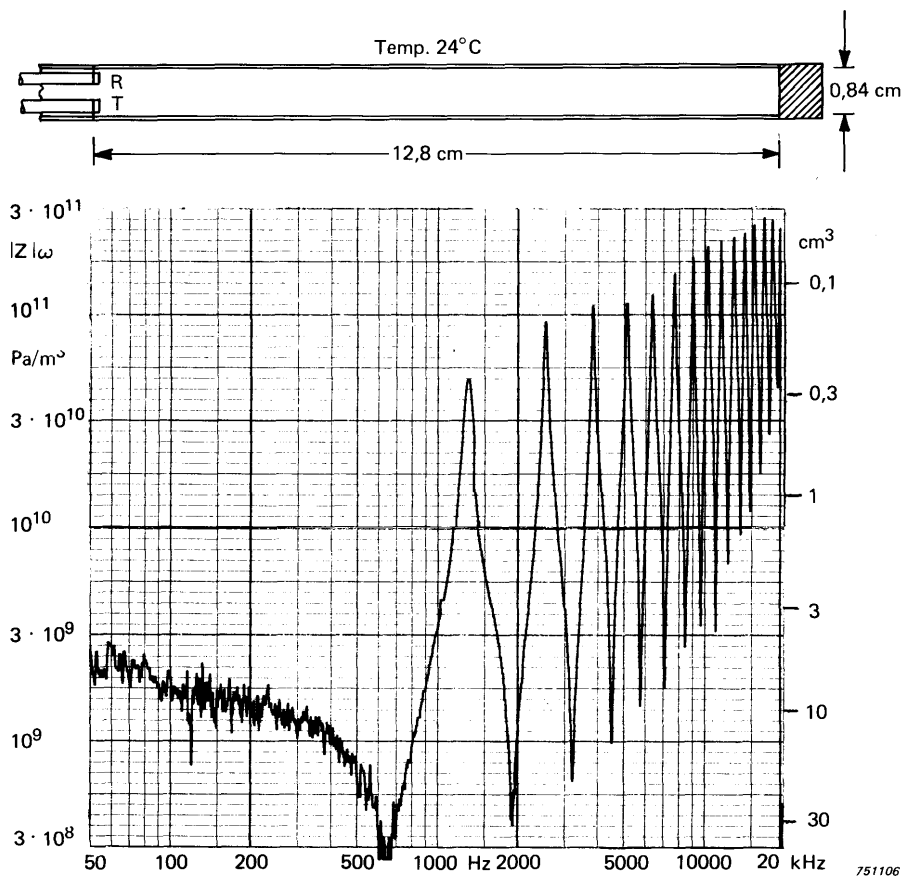

Fig.1A. Impedance measurement into a 12,8 cm long tube

The figure shows an example of an impedance recorded as a function of frequency for a long tube. Both the total volume of  $7 \text{ cm}^3$ , the length of  $12,8 \text{ cm}$  and the whole cotg-function can easily be seen. Expressing the acoustical impedance by an equivalent volume is the same as expressing an electrical impedance by a capacitor with the same nominal impedance value.

In the formula for the impedance of a tube, the attenuation of the sound wave has been neglected. At high frequencies, the reflected wave from the termination of the tube is attenuated. In the limit, at high frequencies, no wave is reflected, and the impedance of the tube is  $\rho c / \pi r^2$ . This is seen in Fig.1A.



## PART III

by

*Per V. Brüel and Erik Sigh*

### Applications of Small Artificial Ears

If the artificial ear is going to be used for determining the frequency response of earphones used in connection with hearing aids, Fig.1B illustrates a very convenient set-up for the purpose. Here the Heterodyne Analyzer Type 2010 acts as a sinusoidal transmitter for the earphone and can supply the earphone with both a constant voltage or a constant current. The heterodyne analyzer also acts as a selective microphone amplifier which can follow the oscillator. The level recorder scans the frequency of the oscillator whereby the frequency response curves of the earphone are directly and conveniently recorded on frequency calibrated paper. The figure shows to the left the new artificial ear and to the right the IEC standard 2 cm<sup>3</sup> coupler.

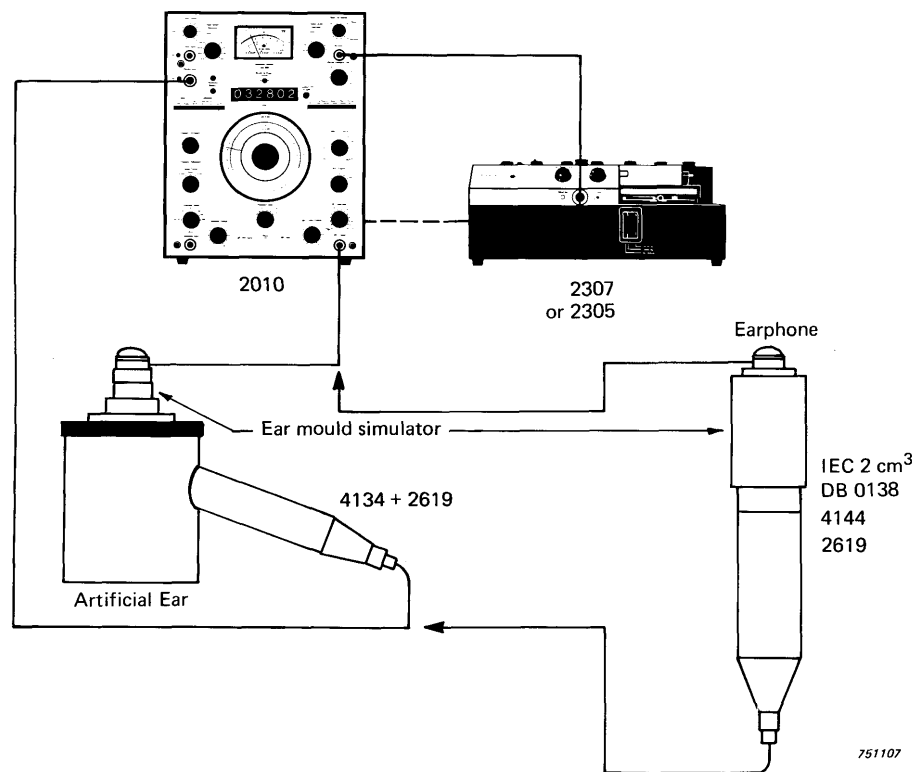

*Fig.1B. Preferred measurement set-up for using artificial ears*

In Fig. 2B are shown the response curves of two different earphones, which are taken both on the new artificial ear and on the IEC 2 cm<sup>3</sup> coupler. The difference, in general, is that the new artificial ear gives a somewhat higher output at low frequencies, because the volume of the new artificial ear is 1,7 cm<sup>3</sup> as opposed to the IEC 2 cm<sup>3</sup>.

However, the really important difference is in the high frequency region where the new artificial ear gives a much higher output than the IEC coupler, because the volume of the new ear is still much smaller, and consequently in much better agreement with the properties of the real human ear.

Below in the figure are shown the same earphones driven by a constant current compared with a constant voltage.

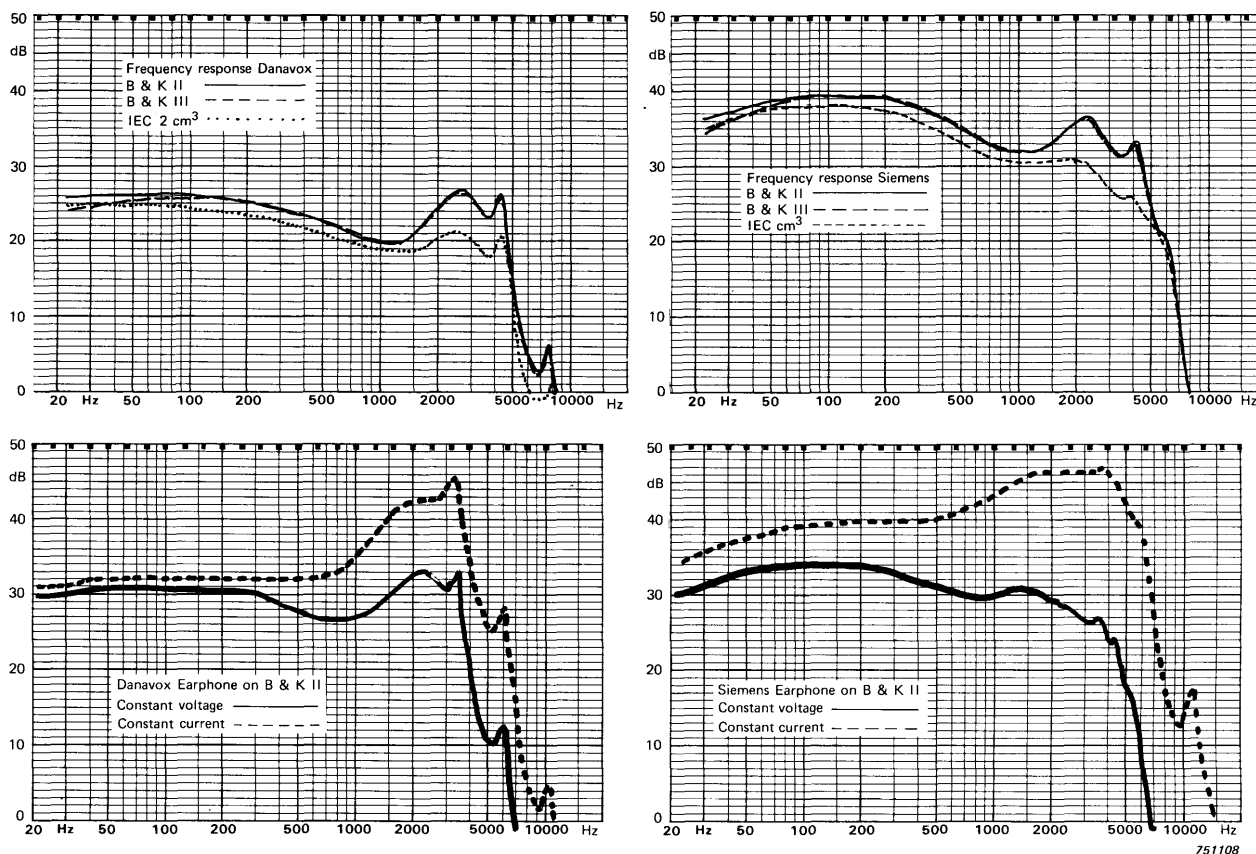
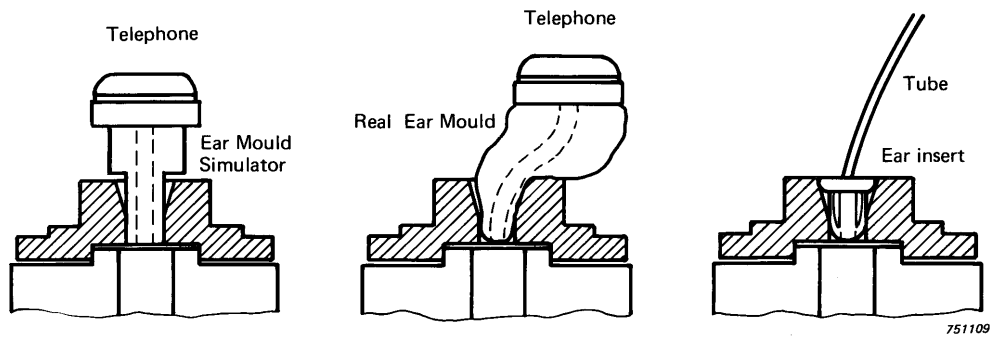

Fig.2B. Frequency response of two typical hearing aid earphones measured on both IEC 2 cm<sup>3</sup> coupler and the new B & K artificial ears Model II and Model III (Top). Below: Curves taken for both constant voltage and constant current. Right: a Siemens earphone and left: a Danavox type

If a hearing aid earphone is supposed to be used in connection with an individually formed ear mould, it should be tested on the ear mould simulator which is an accessory supplied together with the artificial ear. The ear mould simulator has a canal, 22 mm long and 3 mm in diameter. The external diameter of the lower part of the ear mould simulator is 8,5 mm, so that it just fits into that part of the artificial ear that simulates the outer half of the ear canal.

The earphone can also be used together with a real ear mould, in which case the ear mould would have to be formed in such a way that it could penetrate through the outer ear canal until it reached the reference plane, see Fig. 3B. This can be done either by grinding away some ear mould material or by forming the outer canal correspondingly. The connection should be tightened with wax or Plastelinum (a kind of putty).



*Fig.3B. Different ways of adapting hearing aid earphones to the artificial ear*

Some hearing aids have a built-in earphone in which case it is connected to the ear canal by a tube which is held in the ear with a little plug. Also this type of hearing aid can be tested with the new artificial ear just by placing the plug at the end of the tube into the artificial ear so far that the end of the tube is situated at the reference plane.

### **Mannequin (dummy)**



*Fig.4B. Photo of mannequin equipped with an artificial ear B & K Model II*

When the artificial ear is placed inside a mannequin formed and dressed like an average human being, many interesting measurements can be made, since we have here duplicated exactly the pressure distribution and the pressure amplification which occur around a human head. In principle, the artificial ear has to be mounted completely at its outer canal as close as possible to the outer surface of the head through a hole in the pinna. As most mannequin heads are made of glass fibre which can vibrate quite a lot, it is advisable to use the Model II artificial ear, where the heavy mass will be less vulnerable to the vibration. The head itself should be filled with vibration damping materials.

In Fig.4B is shown a photo of the finished mannequin, where the hole in the pinna forming the entrance to the artificial ear can easily be seen.

Fig. 5B shows the internal part of the head and the way in which the artificial ear is placed in the head.



*Fig.5B. Photo of the placing of the artificial ear in the mannequin's empty head*

## Testing of Hearing Aids

The mannequin can now be used to test integrated hearing aids, where microphone and earphone are built together. These hearing aids are normally intended to be worn close to the head. They can be either built into the frame of a pair of spectacles or be built as a small instrument to be worn behind the pinna or in it, but in all cases it is important that the sound distribution around the hearing aid is formed in the same way as the sound reflects from real human beings. For these measurements therefore a mannequin with an artificial ear is a very convenient and useful tool.

To have an impression of the sound distribution and sound reflection which exist around the mannequin head, the mannequin has been placed in an anechoic room as shown in Fig. 6B. The frequency response of a loudspeaker is recorded, first in the free field with the mannequin removed, then through a microphone in the artificial ear on the mannequin.

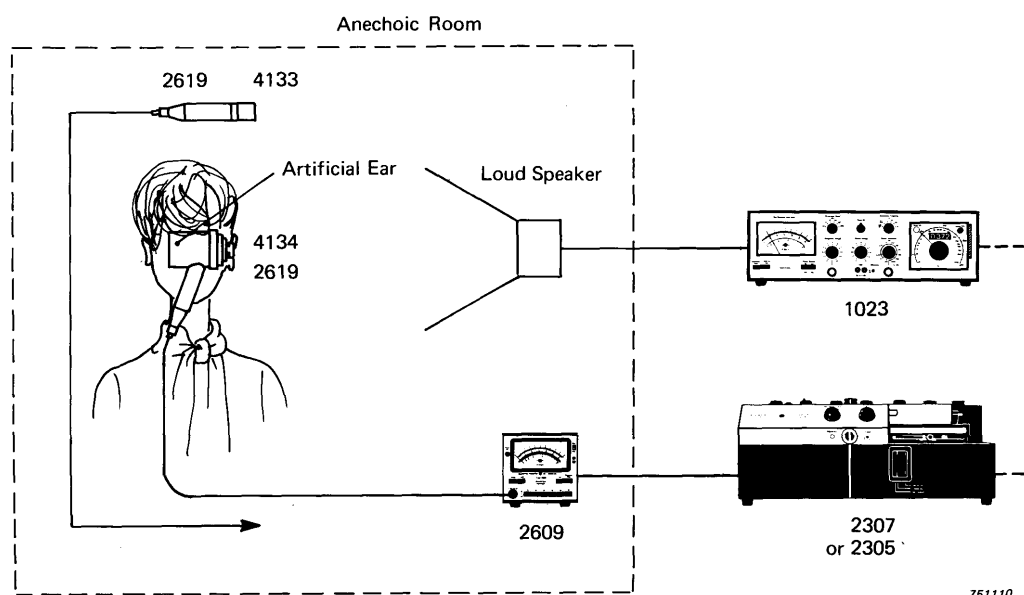

Fig.6B. Measurement set-up in anechoic room for measuring hearing aids and ear plugs for noise protection with help of mannequin supplied with artificial ear

The result is shown in Fig.7B, where the difference between the pressure in the artificial ear and that of the free field is recorded, both when the sound comes frontally to the mannequin and when it comes sideways. It can be seen that in relation to the free field there is a considerable increase in the sound pressure from approx. 300 Hz up to a maximum at approx. 3000 Hz. Above 10—12 kHz there is a decrease in the sound pressure, all in complete analogy with the results found by measurements with human beings.

However, there is one important factor here, concerning the damping in the ear canal. In the artificial ear we have simulated the natural damping in the human ear arising from both the small hairs in the ear canal and the internal damping in the flesh by placing a wire mesh in the inner part of the ear canal. When we also use the outer part of the ear canal, which we do when the artificial ear is placed in the mannequin, it is necessary to introduce the corresponding damping also in the outer part. This is done by placing four layers of fine wire mesh also here. This damping segment has to be placed

in the outer canal, when no other inserts, such as ear mould simulators ear plugs, etc., are placed in the ear canal. The curves shown in Fig.7B are taken with the wire mesh in its right place. If the wire mesh was not there, the resonance at 3000 Hz would be somewhat higher and sharper and would not have the same form as the one found with similar measurements on real human heads.

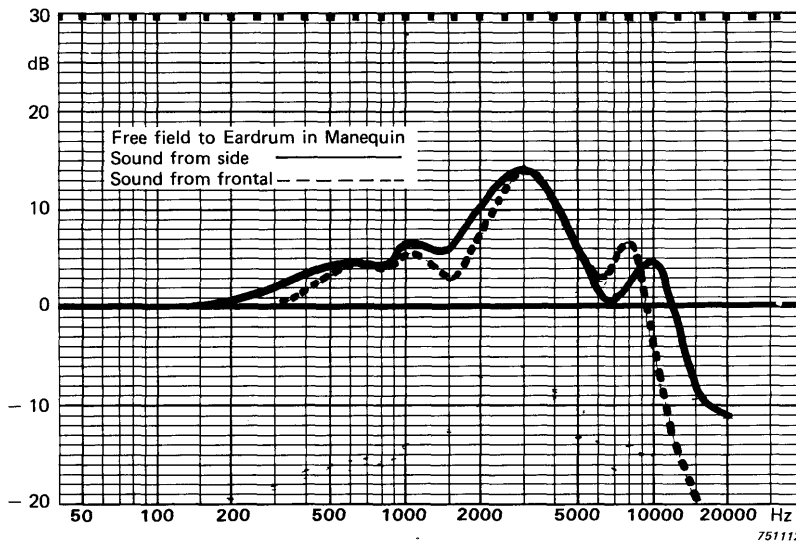

Fig.7B. Ratio between free-field and eardrum pressure in mannequin for sound coming both frontally and sideways

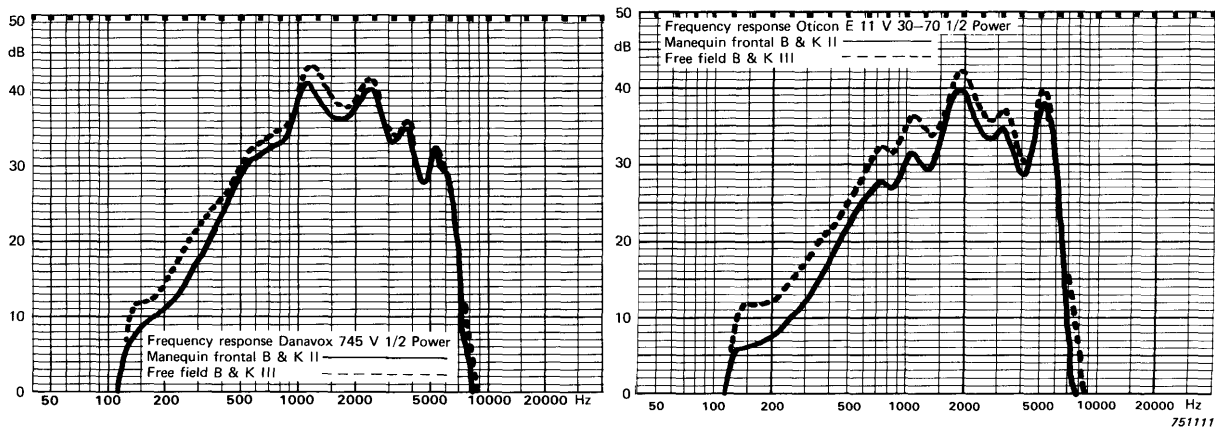

Fig.8B. Left: frequency curves for Danavox hearing aid Model 745 V (1/2 power) recorded on mannequin and in free field according to IEC standard.  
Right: frequency response of Oticon EIIV (1/2 power) on mannequin and in free field

In Fig.8B are shown two response curves taken on a mannequin on some hearing aids. The curves are shown for the sound coming in frontally and are compared with free-field measurements made with the small artificial ear Model III. In the curves the amplification from Model II and Model III has not been kept constant just to show the difference in the curves for very low frequencies.

## Testing of Noise Protection Plugs

Another very useful application for the mannequin is objectively to test noise protection plugs.

Normally, these plugs are tested by making human beings wear them and testing either threshold levels or loudness balance with and without plugs. These measurements are extremely time consuming or inaccurate. To make objective tests requires an absolute duplicate of the impedance of the ear, and that this ear is placed in a mannequin. However, if such an instrument exists, objective tests can be carried out easily by testing a frequency response from a loudspeaker, as shown in Fig.6B, with open ear and with the damping elements placed in the outer canal. The damping element is then removed, the ear plug is placed in the outer canal, the response of the loudspeaker is taken again, and from the difference the damping effect of the noise protection plugs can easily be determined.

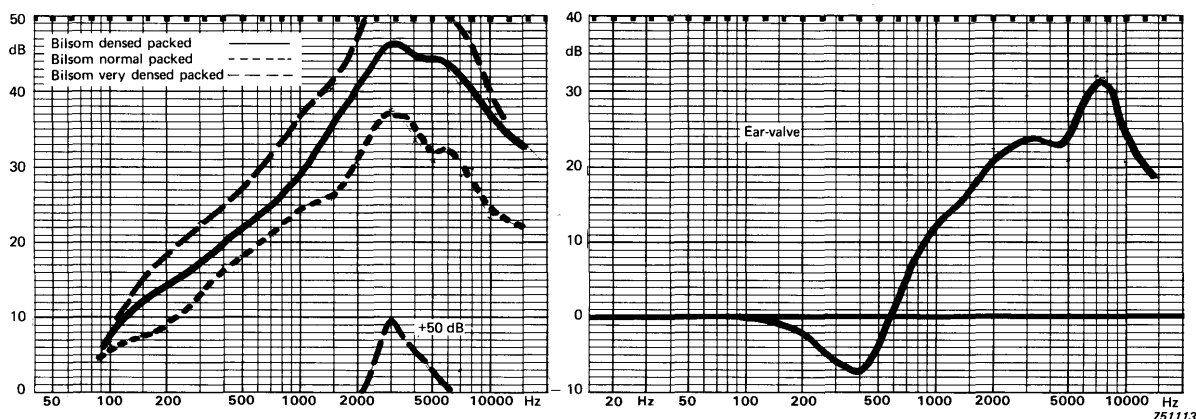

Fig.9B. Left: effective damping of glasswool packed in ear canal with different density  
Right: damping of noise protecting plug "Ear-Valve"

Fig.9B shows results of some practical tests. The curves on the left show attenuation due to glasswool packed with different density. From the curves it is seen that there is remarkable damping which can be obtained from this simple protection device when it is packed correctly. The damping is twofold, as it partly attenuates the sound going through the canal and partly destroys the amplification resonance between 1000 and 5000 Hz.

To the right is shown a common ear plug protector with a rather big hole in the centre used for ventilation. This hole gives rise to an internal resonance at approx. 400 Hz which, of course, directly amplifies the sound at these low frequencies, while the damping at higher frequencies is rather effective.

## Converting a Small Artificial Ear to a Larger one for Testing Supra-aural Earphones

There has been some discussion of the possibility of building up an artificial ear in small stages and adding them together, so that the ear fits different applications. One may think of making the internal half of the ear canal as done here with the new artificial ear, and using this alone for testing instruments penetrating into the ear canal. This artificial ear can be extended by the outer canal to be used in applications where this combination is important, e.g. the applications with the mannequin described.

A further step could be to make a device which duplicates the compressed pinna with the corresponding volumes and the compressibility of the added flesh, for having an artificial ear suitable for measuring on supra-aural earphones. An example of such a device is shown in Fig.10B, where the small artificial ear is extended by a volume also here consisting of two parts, one of which has an effective volume of approx.  $15 \text{ cm}^3$  at the very low frequencies and decreasing to an effective volume of  $2,5 \text{ cm}^3$  for the very high frequencies. This combined device could be used instead of the present standardized IEC artificial ear for audiometric use, which is also at the present the standard for most telephone receiver measurements.

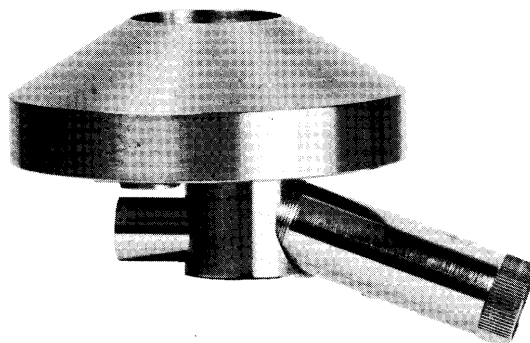

*Fig.10B. Extension of the small artificial ear so that it can be used for supra-aural earphones for audiometric measurement and for telephone receivers*

It may seem very logical to make up an artificial ear in the stages described, but it does not turn out to be very practical, since it is rather complicated to make all the stages completely correct and it seems also difficult to match the different stages together. In any case, it would be a more expensive solution, where many possible errors could be introduced.

We therefore believe that instead of having the logical construction of small pieces, it is much better to look at the problem from the earphone and telephone point of view which require that the artificial ear should have the right acoustical impedance as a function of frequency. If this requirement is satisfied the earphone would be indifferent to whether the artificial ear was built up to look like the human ear or it was different.

For small artificial ears it turns out that some of the dimensions are very close to those of the human ear, but when we come to a larger one, described in the IEC Publication 318, the similarity is gone. However, the IEC Publication 318 has with a rather small number of elements the right impedance and, at the same time, the possibility of going rather high up in frequency, because the microphone is not placed too far from the opening. This high-frequency performance, which is very important for audiometric use, would be very difficult to simulate with a combination of a small artificial ear and some supplementary volumes where the microphone would be placed further away from the entrance.

In the IEC Publication 318 the impedance simulated includes a compressed pinna, where the compliance is quite different from a non-compressed piece of flesh. Consequently, if a further extension of the ear should be made for taking into account circum-aural earphones where the pinna is not compressed, it would be rather difficult to simulate the changes due to the non-compressed pinna in an extension device.

We are therefore convinced that the best way is to build a small artificial ear for insert earphones, use the IEC Publication 318 for normal earphones and telephone receivers and make a special artificial ear for circum-aural earphones which simulates the impedance looked from the earphone.



